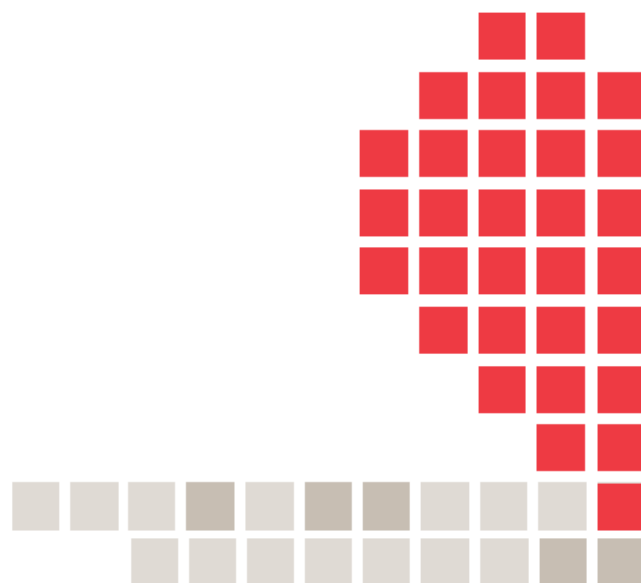


CARDIAC CARE NETWORK



**RECOMMENDATIONS FOR BEST-PRACTICE
STEMI MANAGEMENT IN ONTARIO**

JUNE 2013





CARDIAC CARE NETWORK



CARDIAC CARE NETWORK



4100 Yonge St., Suite 502,
Toronto, ON M2P 2B5

tel 416.512.7472

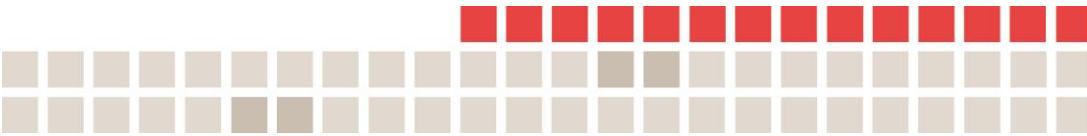
fax 416.512.6425

www.ccn.on.ca

Copyright 2013 Cardiac Care Network

Table of Contents

EXECUTIVE SUMMARY	5
1 INTRODUCTION	11
1.1 CCN'S ROLE IN CARDIAC SERVICE DELIVERY	11
1.2 INTRODUCTION TO STEMI	11
1.3 CCN'S CONTRIBUTIONS IN STEMI CARE	13
1.4 2012 RECOMMENDATIONS FOR BEST PRACTICE	15
1.5 ORGANIZATION OF THIS REPORT	16
2 SURVEY METHODOLOGY	17
2.1 SURVEY DESIGN	17
2.2 SURVEY DISTRIBUTION	17
2.3 SURVEY ANALYSIS	19
3 APPROPRIATE CARE.....	20
3.1 TREATMENT FOR STEMI PATIENTS.....	20
3.2 ACCESS TO STEMI DIAGNOSIS AND TREATMENT IN REMOTE NORTHERN COMMUNITIES	29
3.3 POST-PROCEDURAL MANAGEMENT OF STEMI PATIENTS.....	30
4 TIMELY CARE	35
4.1 TIMELY DIAGNOSIS OF STEMI PATIENTS	36
4.2 TIME TO TREATMENT	41
4.3 REAL-TIME ACCESS TO PATIENT DATA	53
5 QUALITY OF CARE.....	55
5.1 REGIONAL STEMI NETWORKS.....	55
5.2 PROVINCIAL QUALITY ASSURANCE PROGRAM	56
5.3 QUALITY MONITORING	59
6 PERFORMANCE MEASUREMENT	63
6.1 SYSTEM MEASURES	63
6.2 PROCESS MEASURES.....	65
6.3 OUTCOME MEASURES	66
6.4 OTHER REPORTABLE MEASURES	66
7 SUMMARY AND CONCLUSIONS	67
7.1 APPROPRIATENESS OF CARE	67
7.2 TIMELINESS OF CARE.....	67
7.3 QUALITY OF CARE	68
7.4 CONCLUSIONS	68
REFERENCES.....	70
GLOSSARY OF TERMS.....	145



APPENDIX A: PCI CENTRES IN ONTARIO.....76

APPENDIX B: CARDIAC CARE NETWORK STEMI WORKING GROUP MEMBERSHIP.....77

APPENDIX C: RECOMMENDATIONS79

APPENDIX D: PCI HOSPITAL SURVEY81

APPENDIX E: REFERRING HOSPITAL SURVEY.....88

APPENDIX F: EMS SURVEY.....95

APPENDIX G: LHIN SUMMARIES102

APPENDIX H: DRAFT PATIENT INFORMATION REQUIREMENTS141

APPENDIX I: AHSC AFP INNOVATION FUND REPORT EXCERPT– HIGHLIGHTS OF DATA ISSUES142

List of Figures

FIGURE 1: NUMBER OF ACUTE MIS AND STEMIS PER 100,000 ADULT POPULATION, ONTARIO, 2007-2010.....	12
FIGURE 2: WHAT IS THE DOMINANT REPERFUSION STRATEGY YOUR HOSPITAL OFFERS TO STEMI PATIENTS THAT ARE TRANSFERRED OR WALK-IN TO AN ED OF A NON-PCI HOSPITAL IN YOUR REGION? (N=16)	21
FIGURE 3: WHAT TYPE OF REPERFUSION STRATEGY DOES YOUR HOSPITAL OFFER TO PATIENTS DIAGNOSED WITH STEMI BY EMS IN YOUR REGION? (N=16)	22
FIGURE 4: WHAT IS THE PRIMARY STEMI REPERFUSION STRATEGY AT YOUR FACILITY? (N=89).....	22
FIGURE 5: NUMBER OF STEMIS AND NUMBER REPERFUSED PER 100,000 ADULT POPULATION, ONTARIO, 2007-2011	23
FIGURE 6: DISTRIBUTION OF STEMI PATIENTS WITHIN 30 AND 60 MINUTES (BY CAR) OF A PCI CENTRE, SOUTHERN ONTARIO, 2011/12	25
FIGURE 7: DISTRIBUTION OF STEMI PATIENTS WITHIN 30 AND 60 MINUTES (BY CAR) OF A PCI CENTRE, GTA AND CENTRAL ONTARIO, 2011/12.....	26
FIGURE 8: DISTRIBUTION OF STEMI PATIENTS WITHIN 30 AND 60 MINUTES (BY CAR) OF A PCI CENTRE, SOUTH EASTERN ONTARIO, 2011/12.....	27
FIGURE 9: WHAT TYPE OF COVERAGE DOES YOUR HOSPITAL PROVIDE FOR STEMI PATIENTS REQUIRING EMERGENT PCI? (N=16)	28
FIGURE 10: HOW LONG DO STEMI PATIENTS STAY IN CRITICAL CARE BED POST PROCEDURE? (N=16)	31
FIGURE 11: WHAT IS THE TYPICAL LENGTH OF STAY (LOS) POST PROCEDURE AT YOUR INSTITUTION? (N=16).....	31
FIGURE 12: REPATRIATION DESTINATION (N=86)	32
FIGURE 13: MOST FREQUENT BARRIER TO ACCEPTING POST PCI PATIENTS (N=87)	33
FIGURE 14: SIMPLIFIED SYSTEM FLOW OF STEMI PATIENTS.....	36
FIGURE 15: HAVE YOUR PARAMEDICS BEEN TRAINED TO INTERPRET 12-LEAD ECGs? (N=35)	38
FIGURE 16: HOW IS STEMI DIAGNOSED IN THE FIELD? (N=29 FOR PCPS, N=21 FOR ACPs)	39
FIGURE 17: STEMI ACTIVATION LOG: PROPOSAL FOR A 3 STEP CHECKLIST PROCESS.....	45
FIGURE 18: MAXIMUM DRIVE TIME IN MINUTES (OR KM) ALLOWED BY PROTOCOL FROM SCENE TO PCI HOSPITAL (N=23)	46
FIGURE 19: PROTOCOL WHEN STEMI IS DIAGNOSED IN THE FIELD (N=34).....	47
FIGURE 20: BARRIERS WHEN TRANSFERRING STEMI PATIENTS EMERGENTLY TO A PCI HOSPITAL WITH MOST FREQUENTLY OCCURRING (5) TO LEAST FREQUENTLY OCCURRING (1) (N=86)	50
FIGURE 21: MEDIAN TIME FROM CATH LAB ARRIVAL TO BALLOON INFLATION, BY PCI CENTRE, 2011/12	52
FIGURE 22: DO YOU USE ELECTRONIC OR PAPER ACR? (N=35).....	53
FIGURE 23: DEFINITION OF EMS CONTACT FOR E2B (EMS TO BALLOON) TIMES (N=15)	57
FIGURE 24: DEFINITION OF DOOR CONTACT FOR E2D (EMS TO DOOR) TIMES (N=14)	58
FIGURE 25: DEFINITION OF "FALSE POSITIVE" CATH LAB ACTIVATION (N=12).....	58
FIGURE 26: WHAT ED QUALITY INDICATORS DO YOU ACTIVELY MONITOR AS IT RELATES TO STEMI MANAGEMENT? (N=15)	59
FIGURE 27: HOW DO YOU TRACK POST PROCEDURAL OUTCOME INFORMATION FOR STEMI PATIENTS REPATRIATED BACK TO A NON-PCI HOSPITAL? (N=16)	59
FIGURE 28: SAMPLE PROVINCIAL QUALITY INDICATOR REPORT, DOOR-TO-BALLOON TIMES, 2011/12.....	60
FIGURE 29: NUMBER OF PRIMARY PCIs PERFORMED BY CENTRE, 2011/12.....	61
FIGURE 30: NUMBER OF PRIMARY PCI PROCEDURES BY INTERVENTIONALIST, ONTARIO, 2011/12.....	61
FIGURE 31: RECOMMENDED SYSTEM PERFORMANCE INDICATORS FOR TIMELINESS.....	64

List of Tables

TABLE 1: RESPONSE RATE BY LHIN, REFERRING HOSPITAL CORPORATIONS	18
TABLE 2: RESPONSE RATE BY REGIONAL BASE HOSPITAL, EMERGENCY MEDICAL SERVICES	19
TABLE 3: PLEASE RANK THE FOLLOWING BARRIERS TO REPATRIATING PATIENTS POST PCI IN ORDER OF MOST FREQUENTLY OCCURRING (5) TO LEAST FREQUENTLY OCCURRING (1). (N=14)	33
TABLE 4: RECOMMENDED SYSTEM MEASURES	63
TABLE 5: DATA REQUIREMENTS FOR SYSTEM MEASURES (TIME STAMPS ONLY)	65



Executive Summary

Introduction

ST-segment elevation myocardial infarction (STEMI) is a form of heart attack that can cause death if not treated quickly. Approximately one-third of acute coronary syndromes are classified as STEMI (Fitchett, 2011). Data from the Canadian Institute for Health Information (CIHI) Discharge Abstract Database (DAD) suggest that the incidence of STEMI in Ontario is approximately 68 of every 100,000 adult residents, a total of about 7,000 STEMIs per year.

STEMIs are treated through the restoration of blood flow in the coronary artery through one of two treatment options or “reperfusion” modalities:

- Percutaneous coronary intervention (PCI), a procedure in which the coronary arteries are mechanically reopened using a balloon or aspiration catheter and the placement of a stent in the blocked arteries.
- Clot-busting drugs (i.e., fibrinolysis therapy).

Timely reperfusion after STEMI has been shown to reduce mortality (Rollando, 2012) and morbidity (e.g. readmission for heart failure or AMI) (Cantor 2009, Lambert 2010). Timely reperfusion requires timely diagnosis, transportation and treatment when STEMI is diagnosed or suspected, and the timeliness of the intervention is measured in minutes, not days or weeks. The American College of Cardiology/ American Heart Association (ACC/AHA) guidelines recommend that STEMI patients treated by primary PCI presenting to a PCI capable hospital have a door-to-balloon (D2B) time of less than 90 minutes and patients treated with fibrinolysis therapy have a door-to-needle (D2N) time of less than 30 minutes; patients presenting to a non-PCI capable hospital should have a D2B time of less than 120 minutes (ACC/AHA 2011)¹.


In 2011, the Ontario Ministry of Health and Long-Term Care (MOHLTC) asked the Cardiac Care Network of Ontario (CCN) to prepare an environmental scan of the diagnosis and management of STEMI patients in Ontario as a foundation for the development of a provincial strategy for this patient population.

Methods

CCN’s STEMI Working Group undertook to prepare the requested document in four steps:

- Documentation of best practices for the diagnosis and treatment of STEMI patients based on published literature (as available) and expert consensus opinion of the Working Group members.
- Survey of health service providers designed to provide a description of the current state of STEMI care in Ontario, complemented with analysis of administrative data.

¹ Door-to-needle (D2N) time is the elapsed time from when the patient arrives at the emergency department until fibrinolysis therapy is initiated. Door-to-balloon (D2B) time is the elapsed time from when the patient arrives at a PCI or non-PCI hospital until the first balloon is inflated to restore blood flow to the heart.

- 
- Gap analysis based on a comparison of current practice and best practice.
 - Development of consensus recommendations for improvements in the management of STEMI patients in Ontario.

The Working Group surveyed three groups of stakeholders:

- 1 Hospitals that have the capacity to perform PCI (PCI Centres). All PCI Centres completed the survey for a response rate of 100%.
- 2 Hospitals that have an emergency department (ED) but do not have the capacity to perform PCI (Referring Hospitals). The 73 responding hospitals represented 99 individual hospital sites, for a response rate of 62%.
- 3 Emergency Medical Services (EMS) that bring patients to either a Referring Hospital or PCI Centre. The response rate was 63% for EMS.

Findings of Current STEMI Management

Appropriateness of Care

The distinction between appropriate and timely care for STEMI patients is somewhat artificial because how quickly the patient can be treated determines the most appropriate treatment:

- If the recommended timelines can be met, the patient should be referred for primary PCI, and
- If the recommended timelines for primary PCI cannot be met, the patient should be given fibrinolysis, with a view to an early invasive strategy post fibrinolysis.

Using currently available data, the Working Group estimated that approximately 77% of patients diagnosed with STEMI undergo reperfusion (i.e., primary PCI or pharmacological reperfusion). However, there are currently no comprehensive standardized data regarding the total number of STEMIs in Ontario, which creates difficulties in estimating the incidence of STEMI and, therefore, reperfusion rates. Without these data, it is difficult to assess with confidence whether this patient population has access to appropriate and timely care.

Although most of Ontario's population has access to timely therapy for STEMI and a large proportion of Ontario's population lives within 60 minutes drive time of a PCI Centre, residents of some communities in Northern Ontario have limited or no access to timely reperfusion.

Most Referring Hospitals (94%) have a STEMI protocol in place; however, reperfusion strategies vary significantly across hospitals. Although all PCI Centres have (or are developing) a primary PCI program, strategies for reperfusion also vary across centres. The lack of repatriation agreements with Referring Hospitals was cited by some PCI centres as a barrier to providing primary PCI on a 24/7 basis.

Timeliness of Care

Timely access to reperfusion (either primary PCI or fibrinolysis) depends on the timely diagnosis, transport and treatment of STEMI patients.

Paramedics with appropriate training can successfully interpret 12-lead electrocardiograms (ECGs) to identify STEMI patients in the field. However, this equipment is not mandatory for EMS in Ontario. Two



EMS services in the Northeast and Northwest reported that they did not have vehicles equipped with 12-lead ECGs. Among EMS that have protocols in place for the identification of STEMI patients, there is a great deal of variation in the protocols.

Only 77% of Referring Hospital Emergency Departments (EDs) reported having STEMI protocols.

Although delayed cardiac catheterization laboratory (cath lab) activation has been shown to contribute to major delays in the time to treatment for STEMI patients, not all EMS and EDs have protocols in place to ensure timely diagnosis and activation. Similarly, the literature supports the use of bypass protocols to ensure timely transport of STEMI patients directly to the receiving cath lab, such protocols are not in place in all EMS in Ontario. Where they are in use, the protocols are not standardized across the province.

Most PCI Centres have developed treatment plans for STEMI patients mainly focused on access to primary PCI, although many continue to operate without a formal regional network involving EMS and Referring Hospitals. Conversely, not all non-PCI hospitals are affiliated explicitly with a regional STEMI network; protocols for STEMI care, where they exist, vary considerably and are not necessarily consistent with best practice for timely diagnosis, transport and treatment of these patients.

Treating physicians in EDs and in the cath lab must have timely (i.e., immediate) and complete information for STEMI patients across the full continuum of care. Currently, receiving physicians (e.g., in the cath lab) do not always receive information on the patient's condition, diagnostic tests conducted and the results of those tests, or medications administered since symptom onset. Without this information, treatment can be delayed (e.g., while waiting for retesting) or duplicated.

A critical step in the timely diagnosis of STEMI patients is for the patient (or family member) to call 911 rather than proceeding on their own to an ED, which adds to the overall time from symptom onset to diagnosis and treatment. In Ontario in 2012, approximately 36% of diagnosed STEMI patients arrived at EDs on their own. A public service campaign is needed to raise awareness of the importance of calling 911 for medical emergencies. Further research is required to understand the reasons why patients do not call 911, and strategies should be developed to overcome these barriers.

Quality of Care

There is great variability in the information that different health care providers are collecting, monitoring and using for ongoing feedback and evaluation of STEMI care. Even within the hospital sector, there are differences in data definitions. These providers need to be collecting information with a common goal of improving patient outcomes by improving the processes of care. Sharing of data between providers will allow for a harmonized approach to patient care throughout the journey in the healthcare system.

Not all EMS, Referring Hospitals and PCI Centres have formal quality assurance programs specifically for the care of STEMI patients. For example, only 11 (of 33) EMS reported having a dedicated quality assurance process to monitor performance of the STEMI bypass system. Those that do have such programs do not monitor the same indicators or, if they do, the definitions used for the indicators may vary. Accordingly, it is not possible to develop a provincial snap shot of the current delivery of STEMI care or to compare performance across jurisdictions or over time.



Conclusions

The Working Group has articulated two goals for STEMI care in Ontario, which are consistent with the findings and recommendations of the 2004 Report:

- All eligible STEMI patients are reperfused within the recommended timelines,
- If the timelines can be met, the preferred reperfusion strategy is primary PCI.

The Working Group recognizes that some degree of regionalization of services is needed to ensure each centre has a critical mass of patient volumes to maintain competence and achieve operational efficiencies. However, the regionalized nature of primary PCI services creates a need for strategies, based on the best available evidence, to expedite the diagnosis, transport and treatment of STEMI patients to strive for the treatment of all patients within the recommended times.

Accordingly, the Working Group's recommendations address the need for:

- The development of regional networks involving Local Health Integration Networks (LHINs; note that one or more LHINs may be involved), EMS, Regional Base Hospitals, Referring Hospitals, EDs and PCI centres to organize the timely diagnosis and treatment of all STEMI patients.
- The development of protocols for timely processes in each step in the patient's journey from diagnosis to transport to treatment.
- Support for the regional networks (e.g., the ability for EMS to diagnose STEMI patients, and for all members of the care team to have immediate access to patient information to inform the treatment).
- A provincial quality assurance program to define, monitor and report on performance metrics.

The Working Group found that, with a relatively focused investment in a number of limited areas, building on existing infrastructure and resources, significant gains could be expected in the appropriateness, timeliness and quality of care for these patients.

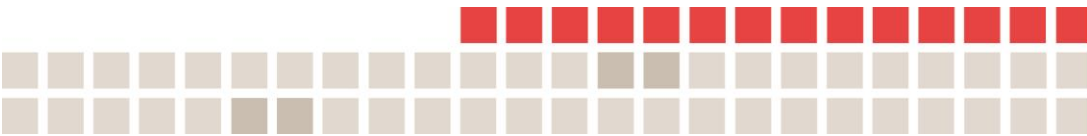
Once implemented, the Working Group's recommendations will result in:

- More efficient use of pre-hospital resources, with some patients travelling directly to the PCI Centre instead of stopping first at the local ED.
- Better patient outcomes (e.g., reduced morbidity and mortality), as patients receive the right care (reperfused) in the right place (PCI Centre) at the right time (within the recommended timelines).

Recommendations

The Working Group identified priority recommendations to address more urgent gaps in the system of care that will have the greatest impact on appropriateness, timeliness and quality of care, including:

Priority Recommendation 1: That all PCI Centres, in collaboration with Regional Base Hospitals, Emergency Medical Services and Referring Hospitals in their catchment area, develop shared and common STEMI protocols to achieve timely access to reperfusion for all patients diagnosed as or suspected of having a STEMI. All Referring Hospitals should have a STEMI protocol with linkages to a PCI Centre.



Priority Recommendation 2: That all PCI Centres, Emergency Medical Services and Referring Hospitals report every diagnosed STEMI case to the Cardiac Care Network of Ontario's cardiac registry, even if the patient is not referred for primary PCI.

Recommendation 3: That the Cardiac Care Network of Ontario STEMI protocols developed to ensure timely and appropriate diagnosis and management of STEMI patients for all remote communities be adopted as the standard of practice in Ontario, supported by Regional Base Hospitals, ORNGE, Emergency Medical Services, and PCI Centres and Referring Hospitals as well as primary care physicians.

Recommendation 4: That the Cardiac Care Network of Ontario develop a standard provincial inter-hospital agreement for the acceptance and repatriation of STEMI patients between Referring Hospitals and PCI Centres that can, in collaboration with Local Health Integration Networks and local health service providers, be adapted to local circumstances. The Ministry of Health and Long-Term Care is asked to mandate the use of these templates. Where current protocols exist for repatriation (e.g., stroke patients), the agreements could be adapted to include STEMI patients.

Recommendation 5: That the Cardiac Care Network of Ontario develop criteria for standardized discharge and repatriation practices that can be adapted for local use by all institutions that treat STEMI PCI patients, in collaboration with their local PCI provider.

Priority Recommendation 6: Ensure that the appropriate infrastructure is in place in Ontario to support timely diagnosis for STEMI patients through the following investments:


- Ensuring that all ambulances and emergency response vehicles in Ontario are equipped with cardiac monitors capable of 12-lead ECG acquisition and ensuring the development of processes for informing the nearest cardiac centre or emergency department of the results.
- Supporting the existing provincial paramedic education program for ECG acquisition and STEMI identification for all paramedics.
- Supporting Regional Base Hospitals to develop a standardized annual education program to ensure ongoing competency in ECG acquisition skill.

Recommendation 7: That every emergency department and urgent care centre in Ontario, in collaboration with the nearest PCI Centre, Regional Base Hospital and Emergency Medical Services, establish a multidisciplinary team (including emergency medicine physicians, cardiologists and nurses) to develop guideline-based, institution-specific, written protocols for triaging and managing patients suspected of or diagnosed as having STEMI.

Priority Recommendation 8: That all Emergency Medical Services establish, in collaboration with area hospital emergency departments, Regional Base Hospitals and the nearest PCI Centre, activation protocols to minimize delays in the acceptance of the patient for primary PCI and arrival of the cath lab team.

Recommendation 9: That all Emergency Medical Services, in collaboration with the Cardiac Care Network of Ontario, Regional Base Hospitals and Referring Hospitals establish local and regional guidelines and rapid transfer protocols to facilitate the timely transfer of STEMI patients directly to a PCI capable site, even when this involves bypassing a closer hospital that does not offer primary PCI.

Recommendation 10: That all Emergency Medical Services, in collaboration with the Cardiac Care Network of Ontario and Regional Base Hospitals, establish guidelines for the identification, notification



and bypass to PCI Centres for transporting patients suspected of or diagnosed as having STEMI where applicable within established regions according to defined inclusion and exclusion criteria.

Recommendation 11: That all Emergency Medical Services establish direct transfer agreements with all area hospitals for the inter-hospital transfer of STEMI patients. These agreements should recognize the emergent nature of these transfers.

Recommendation 12: That the Cardiac Care Network of Ontario develop standardized protocols for the treatment of patients (e.g., antiplatelet and post-lytic management) suspected of or diagnosed as having a STEMI while awaiting transport to a PCI Centre.

Priority Recommendation 13: That health service providers, including Emergency Medical Services, with the support of their Local Health Integration Network, enable the real-time exchange of data for STEMI patients between Emergency Medical Services, other medical facilities and clinics, Referring Hospitals and PCI Centres, including the provision of 12-lead ECG on arrival at the accepting PCI Centre.

Recommendation 14: That all PCI Centres, in collaboration with their Local Health Integration Network, Emergency Medical Services, Regional Base Hospitals and Referring Hospital partners, develop a regional STEMI network to ensure rapid access to appropriate care for all patients diagnosed as or suspected of having a STEMI. All hospitals that treat STEMI patients should be part of a regional STEMI network, in partnership with a PCI Centre (hub-and-spoke model).

Recommendation 15: That the Cardiac Care Network of Ontario, with the support of the Ministry of Health and Long-Term Care, develop a provincial quality assurance program for the care of all STEMI patients. The program should define the indicators to be monitored and the data definitions for those indicators. The data definitions and quality indicators used for this program should be consistent with the pan-Canadian data definitions and quality indicators recently developed by the Canadian Cardiovascular Society and the Cardiac Care Network of Ontario.

Recommendation 16: That the Cardiac Care Network of Ontario, with the support of the Ministry of Health and Long-Term Care, add the data needed for the quality assurance program to its provincial cardiac database and develop protocols for the collection, monitoring and reporting of all STEMI cases across the Province.



Introduction

1.1 CCN's Role in Cardiac Service Delivery

The Cardiac Care Network of Ontario (CCN) serves as a support system to the Ministry of Health and Long-Term Care (MOHLTC) that is dedicated to improving quality, efficiency, access and equity in the delivery of the continuum of adult cardiac services in Ontario. CCN works closely with hospitals to provide leadership in monitoring and managing patient access to cardiac services in Ontario, using skills in information sharing and knowledge translation, and collaboration with key stakeholders at the hospital, regional and provincial levels to identify strategies for best practices and system improvements. In addition, CCN is focusing on issues pertaining to quality, efficiency, access and equity of advanced cardiac services, with ongoing evaluation of specific metrics and indicators of system performance.

CCN is committed to sharing knowledge and information that fosters leading practices and helps to establish benchmarks and standards for optimal care.

1.2 Introduction to STEMI

Coronary artery disease (CAD)² develops when plaque (e.g., fatty materials, calcium) accumulates in the coronary arteries (i.e., the arteries that bring blood to the heart). Risk factors for CAD include those that cannot be changed (e.g., age, sex, family history) and modifiable risk factors (e.g., smoking, hypertension, diabetes mellitus, obesity, a sedentary lifestyle, poor diet).

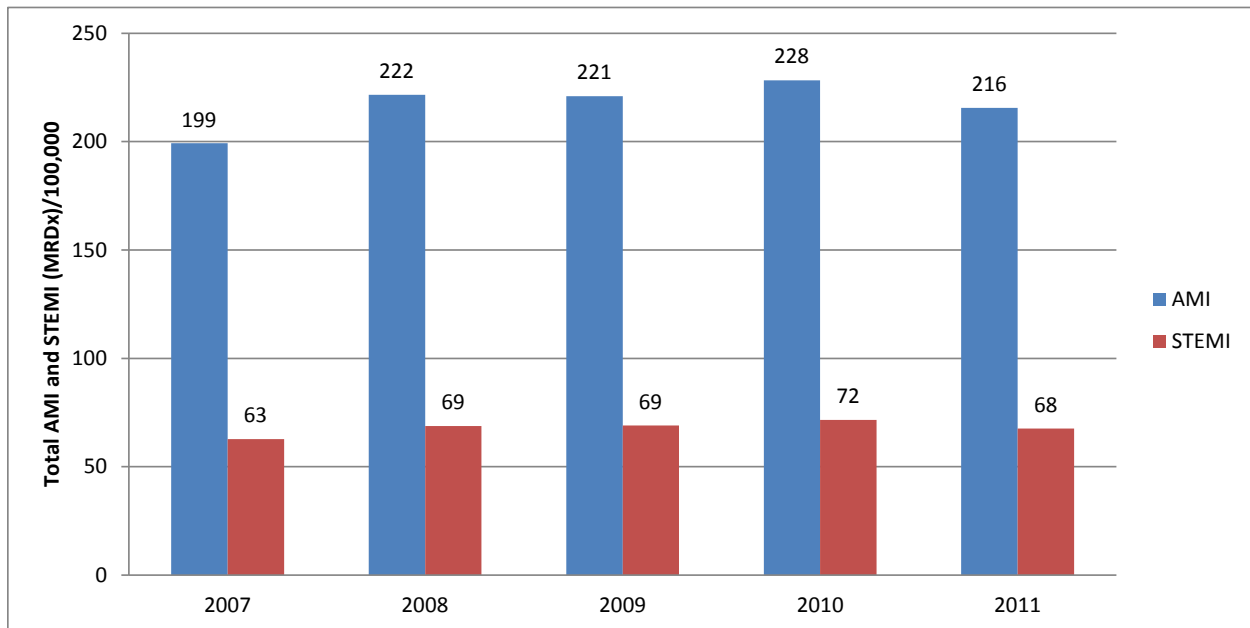
A heart attack (acute myocardial infarction or AMI) occurs when the flow of blood and oxygen to an area of the heart is blocked. Heart attacks occur most commonly when a plaque ruptures and a blood clot forms inside the coronary artery, suddenly stopping the blood flow through the artery. When the heart muscle does not receive enough blood containing oxygen, it becomes damaged and begins to die. The amount of damage increases the longer blood flow is slowed or blocked, and the damage may not be reversible.

ST-segment elevation myocardial infarction (STEMI) is a form of heart attack that can cause death if not treated quickly. Approximately one-third of acute coronary syndromes are classified as STEMI (Fitchett, 2011).

Data from the Canadian Institute for Health Information (CIHI) Discharge Abstract Database (DAD) suggest that the incidence of STEMI in Ontario is approximately 68 of every 100,000 adult residents as shown in Figure 1, a total of about 7,000 STEMIs per year.

² A glossary of technical terms and abbreviations is provided at the end of this report.

Figure 1: Number of Acute MIs and STEMI per 100,000 adult population, Ontario, 2007-2010



MRDx = Most responsible diagnosis.

AMI = Acute myocardial infarction

Source: Canadian Institute for Health Information (CIHI) Discharge Abstract Database (DAD)

The foundation of care for STEMI is the restoration of blood flow in the coronary artery. There are two treatment options or “reperfusion” modalities:

- **Primary PCI** - defined as the mode of reperfusion when the STEMI patient is taken directly to the cath lab to undergo PCI on an emergency basis. Percutaneous coronary intervention (PCI) is a procedure in which the coronary arteries are mechanically reopened using a balloon or aspiration catheter and includes the placement of a stent in the blocked arteries.
- **Fibrinolytics** (i.e., clot-busting drugs).

Fibrinolysis therapy is initiated by a physician in an emergency department (ED) when there is no plan to transfer the patient to a PCI Centre for primary PCI. After fibrinolysis, there are three options for patient management:

1. **Rescue PCI** - The decision to perform rescue PCI is generally made if the patient has ongoing chest pain or ECG changes of STEMI at 60 to 90 minutes following fibrinolysis therapy or, if the patient has recurrent chest discomfort, the patient may be transferred to a PCI Centre for treatment.
2. **Pharmacoinvasive PCI** is when the patient is given fibrinolysis therapy and is transferred immediately to a PCI Centre for an intervention within 24 hours. The transfer to the cath lab is not dependent on the response to fibrinolysis therapy but rather on the risk profile of the patient.
3. **Other** - If the patient is low risk and is otherwise clinically stable after successful reperfusion with fibrinolysis therapy, the patient may be admitted to the local critical care unit and scheduled for PCI during the hospital admission.



Collectively, these three types of PCI (primary, rescue and pharmacoinvasive) are referred to as "STEMI PCI". All patients referred for STEMI PCI undergo diagnostic coronary angiography prior to PCI to determine the coronary anatomy.

Timely reperfusion after STEMI has been shown to reduce mortality (Rollando, 2012) and morbidity (e.g. readmission for heart failure or AMI) (Cantor 2009, Lambert 2010). The American College of Cardiology/American Heart Association (ACC/AHA) guidelines recommend that STEMI patients treated by primary PCI presenting to a PCI capable hospital have a door-to-balloon (D2B) time of less than 90 minutes and patients treated with fibrinolysis therapy have a door-to-needle (D2N) time of less than 30 minutes; patients presenting to a non-PCI capable hospital should have a D2B time of less than 120 minutes (ACC/AHA 2011)³.

1.3 CCN's Contributions in STEMI Care

Over the past 10 years, CCN has been involved in providing support and establishing best practices for STEMI care in Ontario:

- In 2004, CCN convened an expert panel to explore the current state and provide recommendations to hospitals and policy makers on how to achieve optimal outcomes for patients when providing STEMI care.
- Following the 2004 Report, CCN established a subcommittee of the CATH/PCI Working Group to create a registry to capture all STEMI patients undergoing PCI in the province.
- The subcommittee also produced a coaching document that highlighted best practices and important steps to create a successful regional primary PCI program (2010).
- In 2011, a multidisciplinary working group was formed to provide a provincial strategy for STEMI care, beyond what has been accomplished for primary PCI.


1.3.1 Access to Urgent PCI for ST Segment Elevation Myocardial Infarction (2004 Report)

In the fall of 2002, the MOHLTC asked CCN to convene an expert consensus panel (the Panel) on Access to Urgent PCI for ST Segment Elevation Myocardial Infarction. The mandate of this Panel was to develop recommendations regarding the coordination and provision of urgent PCI for the province of Ontario.

The success of treating patients with STEMI was found to be dependent on appropriate patient selection and timely treatment. Therefore, the Panel recommended that reperfusion therapy, whether PCI or fibrinolysis therapy, be offered to all STEMI patients presenting within 12 hours of symptom onset. Based on the available evidence, it was also recommended that primary PCI become the dominant strategy for the reperfusion of STEMI in Ontario. Fibrinolysis therapy was to remain an important treatment for patients for whom primary PCI was not available in a timely manner and for patients presenting very early after symptom onset.

The Panel also recommended the establishment of a provincial monitoring system for STEMI in Ontario to assess the impact of the recommended system changes and the model of care on patient access,

³ Door-to-needle (D2N) time is the elapsed time from when the patient arrives at the ED until the fibrinolysis therapy is initiated. Door-to-balloon (D2B) time is the elapsed time from when the patient arrives at a PCI or non-PCI hospital until the first balloon is inflated to restore blood flow to the heart.



quality of care and health outcomes. The Panel also recommended centralized coordination of the PCI programs across municipalities to create efficiencies and shared learning.

After the 2004 report was issued, four hospitals⁴ implemented regional and integrated primary PCI STEMI networks to meet the needs of their communities. In addition to achieving improved outcomes for STEMI patients, these centres also found benefits in the ongoing program evaluation, process improvement and development of collaborative relationships. Today, most PCI centres have a primary PCI program, although most continue to operate without a formal regional network involving all their Emergency Medical Services (EMS) providers and Referring Hospitals.

Another outcome of this panel was the implementation of an ongoing provincial monitoring system that was officially launched in 2006 when CCN established a primary PCI registry as a first step in the provincial monitoring of the management of STEMI patients.

1.3.2 The CCN CATH/PCI Working Group Primary PCI Subcommittee

In recognition of what is required to support the successful implementation of integrated regional primary PCI services in Ontario, the CCN CATH/PCI Working Group established the primary PCI Subcommittee (pPCI-SC) to provide guidance to the broader acute care cardiac community on service organization and stakeholder collaboration at the system, organizational and local level. The pPCI-SC members were experienced in establishing primary PCI programs and represented the 24/7 regional integrated EMS primary PCI networks in Ontario.

The scope of the pPCI-SC was to review four fully operational, integrated regional primary PCI networks in Ontario and identify key success factors and significant lessons learned, as well as the critical steps required for implementation. The specific deliverables included:

- The creation of a coaching document to assist hospitals, Local Health Integration Networks (LHINs), and policy makers in the planning and implementation of an integrated primary PCI program (See Section 1.3.3 below).
- A document that would be based on the recommendations from the *Report on Access to Urgent PCI*, as well as expert opinion relevant to the lessons learned from networks that had successfully implemented a fully operational, integrated regional model for 24/7 primary PCI.
- Expansion of an existing registry to include primary PCI cases in Ontario, with variables and data definitions aligned with major organizations in other jurisdictions and best-practice guidelines.

1.3.3 Primary Percutaneous Coronary Intervention: Optimizing Access to Primary PCI for ST Elevation Myocardial Infarction (2010 Report)

The 2010 Report stated that fibrinolysis therapy remains a therapeutic option for STEMI patients who are unable to receive primary PCI and that pre-hospital diagnosis of STEMI in the context of a regional network has the potential to expand the geographic reach of primary PCI based on existing capacity.

The 2010 Report provided four guiding principles for the development of a primary PCI program:

⁴ In order of implementation: University of Ottawa Heart Institute, Kingston General Hospital, Hamilton Health Sciences Centre and Southlake Regional Health Centre.



1. Delivering primary PCI services requires the advanced skills of a well-established PCI program, experienced in the care and management of high risk, acutely ill patients.
2. A comprehensive primary PCI program should include service availability for STEMI or AMI patients 24 hours a day, 7 days a week.
3. Ensuring the 24/7 availability of primary PCI services does not place extraordinary burden on hospital system resources, including health human resources.
4. To optimize efficiency, primary PCI services will require a minimum of two cardiac cath labs on-site.

Today, Ontario has 16 hospitals providing PCI services: 11 full-service cardiac hospitals with on-site cardiac surgery and five stand-alone centres without cardiac surgery back up. (See Appendix A for a list of centres and the services offered at each centre.)

1.3.4 2011 STEMI Working Group

Recognizing the complexity in establishing regional STEMI networks, the isolation in which the programs were built, and the need to accurately capture utilization and performance data for ongoing monitoring, feedback and evaluation, CCN established a STEMI Working Group (the Working Group) in the summer of 2011. The Working Group is a multisectoral and multidisciplinary group that includes general cardiologists, interventional cardiologists, hospital administrators and representatives of emergency medical services from across the province. A list of the Working Group members is provided in Appendix B.

The mandate of the Working Group is to ensure the delivery of high quality, evidence based STEMI care for all patients in Ontario as they move through the healthcare system.

1.4 2012 Recommendations for Best Practice

In 2011, the MOHLTC asked CCN to prepare an environmental scan of the diagnosis and management of STEMI patients in Ontario as a foundation for the development of a provincial strategy for this patient population. The STEMI Working Group undertook to prepare the requested document in four steps:

- The first step was to document best practices for the diagnosis and treatment of STEMI patients. This documentation was based on existing literature and, where no published literature was available, on the expert consensus opinion of the Working Group members.
- The second step was a suite of surveys designed to provide a description of the current state of STEMI care in Ontario against which the Working Group could compare to best practice.
- A comparison of current practice and best practice was then conducted to identify gaps in the management of STEMI patients in Ontario and to assess which gaps had the greatest impact on patient outcomes to determine priorities for action.
- Based on the identified gaps and the associated priorities for addressing these gaps, the Working Group then developed consensus recommendations for improvements to the management of STEMI patients in Ontario.



1.5 Organization of this Report

The Working Group's primary concern in the development of a system of care of STEMI management in Ontario was to consider the need for access to the most appropriate interventions (i.e., primary PCI or fibrinolysis therapy), the need to access those interventions as quickly as possible, and the need to ensure that the interventions are high quality and deliver optimal patient outcomes. Accordingly, the report is organized around the three topics of **appropriateness, timeliness and quality of care** for STEMI patients in Ontario. The Working Group recognizes that appropriateness and timeliness are interdependent for STEMI care (i.e., the most appropriate intervention changes depending on the expected time to treatment), resulting in some overlap between the topics.

The best-practice documentation, the survey results describing current practice and the gap analysis are summarized for each of these topics, followed by the Working Group's recommendations for the highest impact initiatives and investments to close the identified gaps in care.

The report also includes a proposed quality assurance process, with recommended performance indicators to evaluate the management of STEMI patients and to contribute to continuous improvement in the planning and delivery of STEMI care across Ontario.

A summary listing of the Working Group's recommendations is provided in Appendix C.



Survey Methodology

The design, distribution and analysis of the survey results were conducted under the guidance of the Working Group.

1.6 Survey Design

Three distinct target audiences were identified for the surveys:

1. Hospitals that have the capacity to perform PCI (hereafter referred to as PCI Centres).
2. Hospitals that have an ED but do not have the capacity to perform PCI (hereafter referred to as Referring Hospitals).
3. Emergency Medical Services (EMS) that bring patients to either a Referring Hospital or PCI Centre.

The initial design for the surveys was taken from surveys used in 2004, as documented in CCN's report titled "Access to Urgent PCI for STEMI" (CCN, 2004). The three draft surveys were adapted to reflect current circumstances in Ontario and sent to all Working Group members for detailed review and comment. The EMS survey was also sent to Ontario Base Hospital Group (OBHG) Medical Advisory Committee (MAC).

Urgent care centres were not included in the survey distribution. All recommendations that are made for EDs at Referring Hospitals apply equally to urgent care centres.

Copies of the final surveys are provided Appendix D (PCI Hospitals), Appendix E (Referring Hospitals) and Appendix F (EMS).

1.7 Survey Distribution

The three surveys were posted to the Internet using SurveyMonkey, a web-based survey tool.

Respondents were identified from each of the three target audiences as follows:

- For PCI Centres, a request to complete the survey was sent to the Medical Director of the cath lab or the STEMI program lead at the centre.
- For Referring Hospitals, a list of target hospitals was developed using data from the Ontario Hospital Association (OHA) website. All hospitals that do not have an ED⁵, paediatric hospitals and all PCI Centres were removed from the OHA list. The Chief Executive Officers of the remaining hospitals were sent a request to forward the survey to the ED manager or the medical director to complete the survey.
- For EMS, a request was sent to the chief of each EMS as posted on the Ontario Association of Paramedic Chiefs (OAPC)⁶ website.

⁵ Hospitals that provide rehabilitation, complex continuing care, and mental health and addiction services with no acute beds.

⁶ Formerly the Association of Municipal Emergency Medical Services of Ontario (AMEMSO)

Respondents were asked to complete the survey within two weeks. Reminders were sent towards the end of this period to those hospitals and EMS that had not yet completed the survey. Targeted calls were made to non-responding organizations to ensure an acceptable response rate and that survey results were as representative as possible of all 14 LHINs.

Referring Hospitals were asked to respond once for every acute site. The 73 responding hospitals represented 99 individual hospital sites.

All PCI Centres completed the survey for a response rate of 100%. The response rate was 62% for Referring Hospitals (number of hospital corporations shown by LHIN in Table 1) and 63% for EMS (shown by Regional Base Hospital in Table 2).

Table 1: Response Rate by LHIN, Referring Hospital Corporations

LHIN	Referring Hospitals in LHIN	Hospital Corporations Responding	Response Rate (%)
Erie St. Clair	6	6	100
South West	18	9	50
Waterloo Wellington	6	1	17
Hamilton Niagara Haldimand Brant	9	8	89
Central West	1	0	0
Mississauga Halton	2	1	50
Toronto Central	3	3	100
Central	5	4	80
Central East	7	7	100
South East	5	3	60
Champlain	16	7	44
North Simcoe Muskoka	5	5	100
North East	23	12	52
North West	11	7	64
	116	73	62



Table 2: Response Rate by Regional Base Hospital, Emergency Medical Services

Regional Base Hospital	Identified OAPC partners	EMS Responding	Response Rate (%)
Central East Pre-hospital Care Program	6	4	67
Hamilton Health Sciences	9	3	33
Northeastern Ontario Pre-Hospital Care Program	12	2	17
Regional Paramedic Program for Eastern Ontario	9	7	78
Southwest Ontario Regional Base Hospital	10	9	90
Sunnybrook Centre for Pre-Hospital Medicine	7	7	100
Thunder Bay Regional Base Hospital	3	3	100
Total Ontario	56	35	63

1.8 Survey Analysis

The preliminary survey data were analyzed as of March 12, 2012. Using this cut-off date, duplicate entries were identified, and sites with duplicate records were contacted to provide guidance where the duplicate surveys were not the same.

Summary survey results for all questions were prepared for discussion at a half-day meeting of the Working Group. Based on the discussion and feedback from this session, the final dataset (as of June 15, 2012) was analyzed with additional focus on areas of particular interest. Findings that are relevant to the Working Group's analysis of best practice and services gaps in Ontario are incorporated into the body of this report as appropriate.



Appropriate Care

Timely reperfusion after STEMI has been shown to reduce mortality (Rollando, 2012) and morbidity (e.g. readmission for heart failure or AMI) (Cantor 2009, Lambert 2010). All medical interventions need to be timely; however, for STEMI patients, timeliness of care is measured in minutes, not days or weeks. For STEMI patients, the most appropriate treatment modality (primary PCI vs. fibrinolysis) depends on how quickly the patient can be treated.

Therefore, the distinction between appropriate and timely care for STEMI patients is somewhat artificial. For the purpose of this report, this chapter on appropriate care describes best-practice treatment and post-procedural management of STEMI patients, assuming the patient is treated within the recommended timelines. The issue of timeliness of STEMI care is discussed in the next chapter.

1.9 Treatment for STEMI Patients

1.9.1 Best-Practice Treatment

Patients with ischemic chest pain of onset within the past 12 hours and ECG abnormalities consistent with an acute STEMI should be considered for reperfusion strategy either by primary PCI or fibrinolysis therapy. Primary PCI is the preferred reperfusion strategy with improved outcomes compared to fibrinolysis therapy when performed by experienced operators and teams within the recommended D2B time. Immediate fibrinolysis therapy (within 30 minutes) should be considered if transfer times are likely to be beyond 90 minutes for EMS to PCI site cases or beyond 120 minutes for non-PCI site to PCI transfer cases for primary PCI.

Patients presenting with STEMI should receive optimal care regardless of where they present. Every patient presenting with STEMI should be part of a system or network of care that ensures timely access to reperfusion therapy with primary PCI being the preferred method whenever feasible.

The importance of timely reperfusion was reinforced by a recent publication in the Canadian context (Lambert, 2010). These investigators found that patients treated outside of recommended benchmarks, regardless of whether they were treated with primary PCI or fibrinolysis, had significantly worse outcomes compared to patients treated within benchmark times. However, patients who received either therapy for STEMI within the benchmark (90 minutes for primary PCI and 30 minutes for fibrinolysis therapy) had improved outcomes compared to those treated beyond the benchmarks, indicating there is significant benefit to receiving timely reperfusion therapy. This paper emphasizes that timely reperfusion is of greater importance than the modality of reperfusion per se. Based on previous work, and consistent with previous CCN recommendations, when both primary PCI and fibrinolysis therapy can be delivered well, primary PCI is the preferred option.

1.9.2 Current Practice

The current practice in the treatment of STEMI patients is discussed below under three topics:

- The choice of reperfusion strategy at the PCI Centre.
- Reperfusion rates for Ontario.
- The availability of primary PCI across Ontario.



Reperfusion Strategies

All but one of the 16 PCI Centres reported having STEMI protocols in place. The one centre that reported not having a STEMI protocol was in the process of ramping up to provide primary PCI for STEMI according to the operational plan submitted as part of its application for operating a stand-alone PCI Centre as of January 2012. A description of each primary PCI network in Ontario is provided in Appendix G.

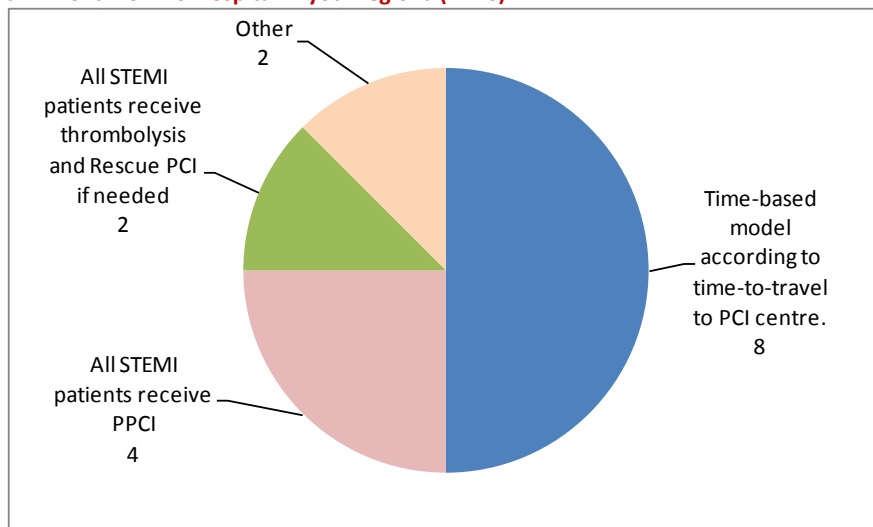
Although most PCI Centres have a regional STEMI program, the nature of regional access to emergent PCI varies significantly across the province:

- Eleven PCI Centres have a prescriptive process for determining the reperfusion strategy in which the PCI Centre has established the treatment algorithm for the Referring Hospitals in the area.
- One has a discretionary process in which the Referring Hospital makes the decision.
- Four reported a combination (e.g., depending on time of day and /or subject to consultation with an interventionalist).

The reperfusion strategy varies by both the centre and by type of patient (walk-in vs. EMS vs. inter-hospital transfer). Thirteen PCI Centres reported that all of their STEMI patients presenting directly to their institution receive primary PCI; the remaining two centres reported that they are moving towards providing primary PCI for all patients.

The dominant reperfusion strategy for STEMI patients transferred from another hospital varies by PCI Centre providing the service, with one-half of the PCI Centres (eight of 16) reporting a time-based model to determine reperfusion strategy, four hospitals treating all STEMI patients with primary PCI, and four reporting other protocols, as shown in Figure 2.

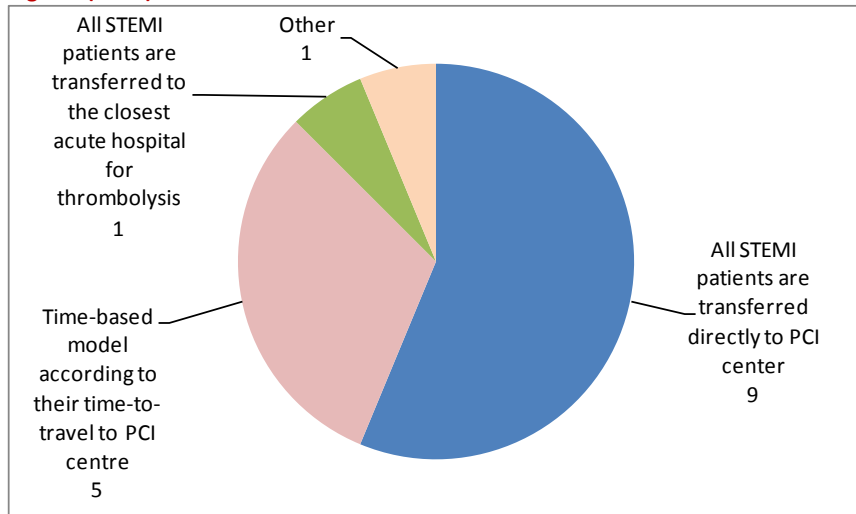
Figure 2: What is the dominant reperfusion strategy your hospital offers to STEMI patients that are transferred or walk-in to an ED of a Non-PCI hospital in your region? (N=16)



Source: Question 11. PCI Hospital Survey, March 2012

The dominant reperfusion strategy for STEMI patients whose first contact is with EMS also varies by centre, with nine of 16 reporting that all STEMI patients are transferred directly to a PCI Centre; and five having a time-based model, as shown in Figure 3.

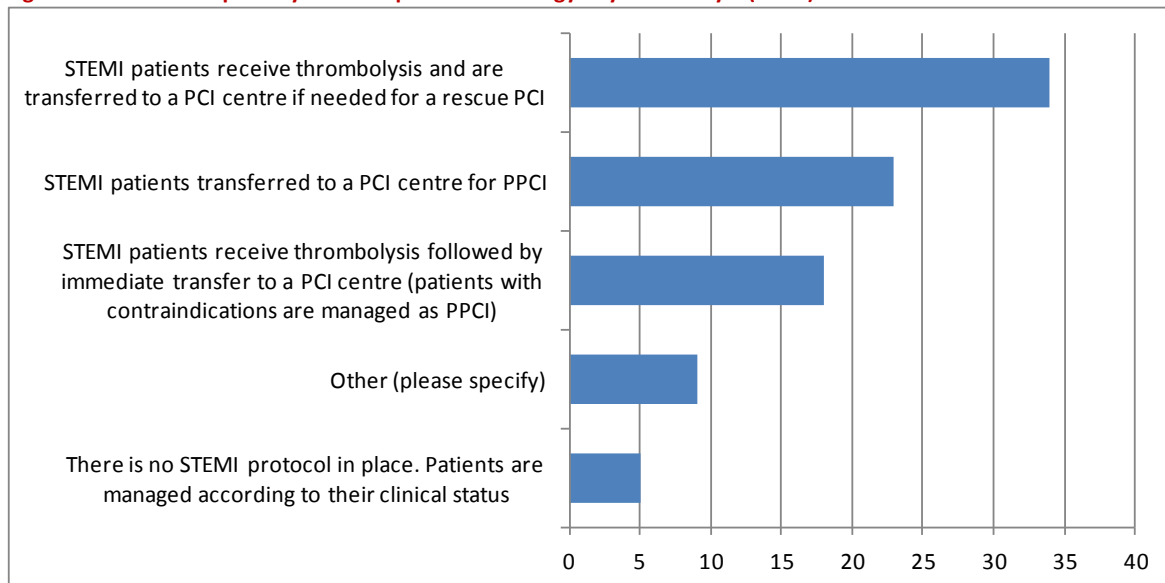
Figure 3: What type of reperfusion strategy does your hospital offer to patients diagnosed with STEMI by EMS in your region? (N=16)



Source: Question 12. PCI Hospital Survey, March 2012

The primary STEMI reperfusion strategy reported by Referring Hospitals varies widely. Of 89 Referring Hospital sites that responded to this question, five (6%) hospitals reported that they do not have a STEMI protocol in place, and 35 (40%) reported that they do not have a back-up strategy if the primary strategy is not available. (See Figure 4.)

Figure 4: What is the primary STEMI reperfusion strategy at your facility? (N=89)



Source: Question 13. Non-PCI Hospital Survey, March 2012



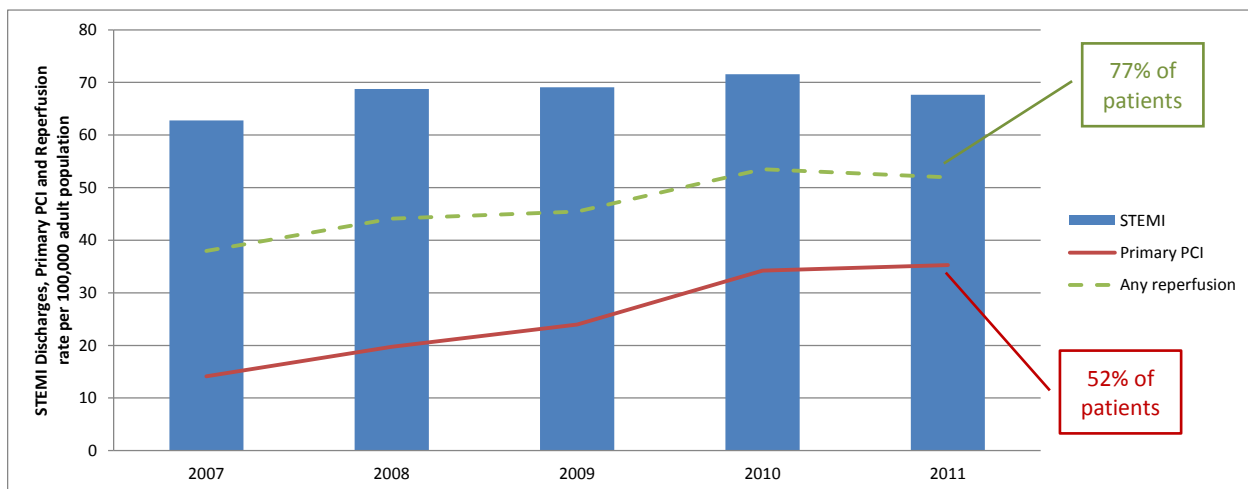
1.9.3 Reperfusion Rates

There is currently a paucity of data on the total number of STEMI in the province and, thus, the proportion who receive appropriate reperfusion. Recent modifications to the coding system in the CIHI-DAD allow for specification of whether a myocardial infarction is a STEMI and if that patient received primary PCI or fibrinolysis therapy. However, there has been sub-optimal use and variation in use of these codes by hospital abstractors, and the data have not been validated for accuracy. This situation represents a substantial gap in the ability to monitor the care of these patients.

Despite these limitations, as seen in data from CCN's Wait Time Information System (WTIS), 35/100,000 adults in Ontario were treated with primary PCI in 2011/12, which represents a point estimate of 52% of all STEMI patients. The proportion treated is higher (77%) if patients treated with fibrinolysis therapy are included. As shown in Figure 5, the proportion of STEMI patients who are reperfused rose from about 61% in 2007/08 to 77% in 2011/12. Data from Quebec (Lambert, 2010) suggested that the proportion of STEMI patients in that province who are not reperfused was 22%.

Although the exact proportion of non-reperfused STEMI patients in Ontario is not known, these data suggest it is not ideal and that both better data collection and reporting are needed, and the underlying reasons for withholding reperfusion therapy must be elucidated. Recent reports from experiences in North America and Europe suggest that appropriate identification of treatment-eligible patients and substantial improvements in non-reperfusion rates are possible with well organized networks (Huber, 2013).

Figure 5: Number of STEMI and Number Reperfused per 100,000 adult population, Ontario, 2007-2011



Source: STEMI rates: Canadian Institute for Health Information (CIHI) Discharge Abstract Database (DAD)
 Procedure rates: Wait Time Information System (WTIS) off-listing

Recent data suggest that there is variation in reperfusion practices across the province. However, concerns about data quality do not allow a reliable assessment of the degree of variation or the causes of this variation. A system is needed to better quantify the number of residents who require reperfusion, and the proportion of them who are reperfused.



1.9.4 Availability of Primary PCI

The availability of primary PCI varies across the province based on:

- The STEMI patient's proximity to a PCI Centre.
- The availability of primary PCI at the PCI centre.

Proximity to a PCI Centre

A study of travel times by car to the nearest hospital that provides specialized services (such as PCI) showed that only 40.5%⁷ of the population living in communities with 30,000 or fewer people were within 30 minutes and only 72.2% were within 60 minutes of these hospitals.

Hospital EDs are somewhat more accessible in Ontario, with only 2.2% of Ontario's population living further than a 30-minute drive from an ED, and only 1.0% further than a 60-minute drive (Glazier, 2011).

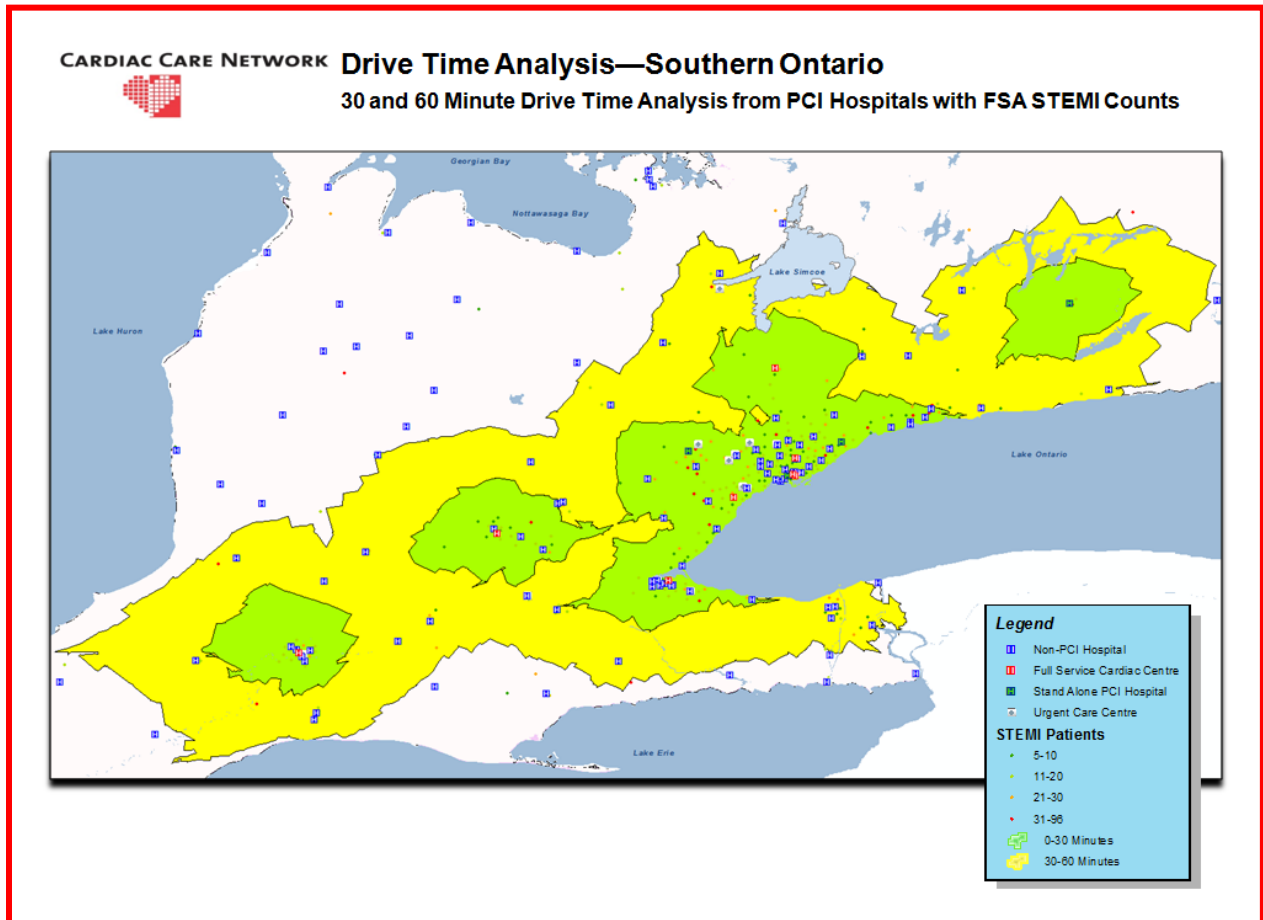
The drive times for STEMI patients to the nearest PCI Centre are shown for Southern Ontario, (Figure 6), Greater Toronto Area (GTA) and Central Ontario (Figure 7) and South Eastern Ontario (Figure 8). In the figures, the area shaded in green shows 30 minutes or shorter drive time; the area shaded in yellow shows 60 minutes or shorter drive time. As shown in the figures, most of the STEMI patients are within 60 minutes of a PCI Centre. However, these figures do identify a number of patients who are outside of the 60-minute threshold.

More detailed analyses of drive times to a PCI centre by LHIN are provided in Appendix G.

⁷ 1.05 million out of 2.59 million people living in communities with 30,000 or fewer people.

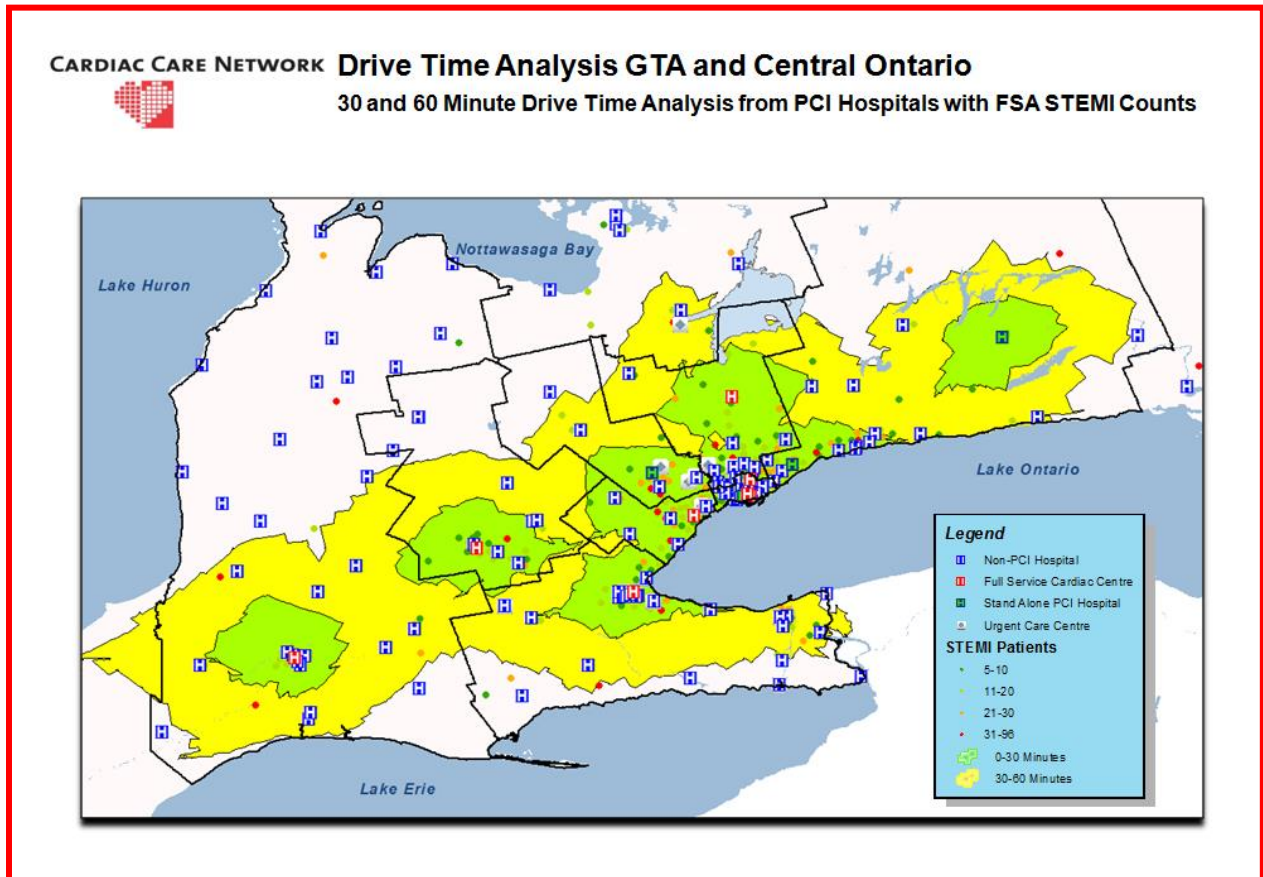


Figure 6: Distribution of STEMI patients within 30 and 60 minutes (by car) of a PCI Centre, Southern Ontario, 2011/12



Source: CCN, using CIHI DAD, 2011/12

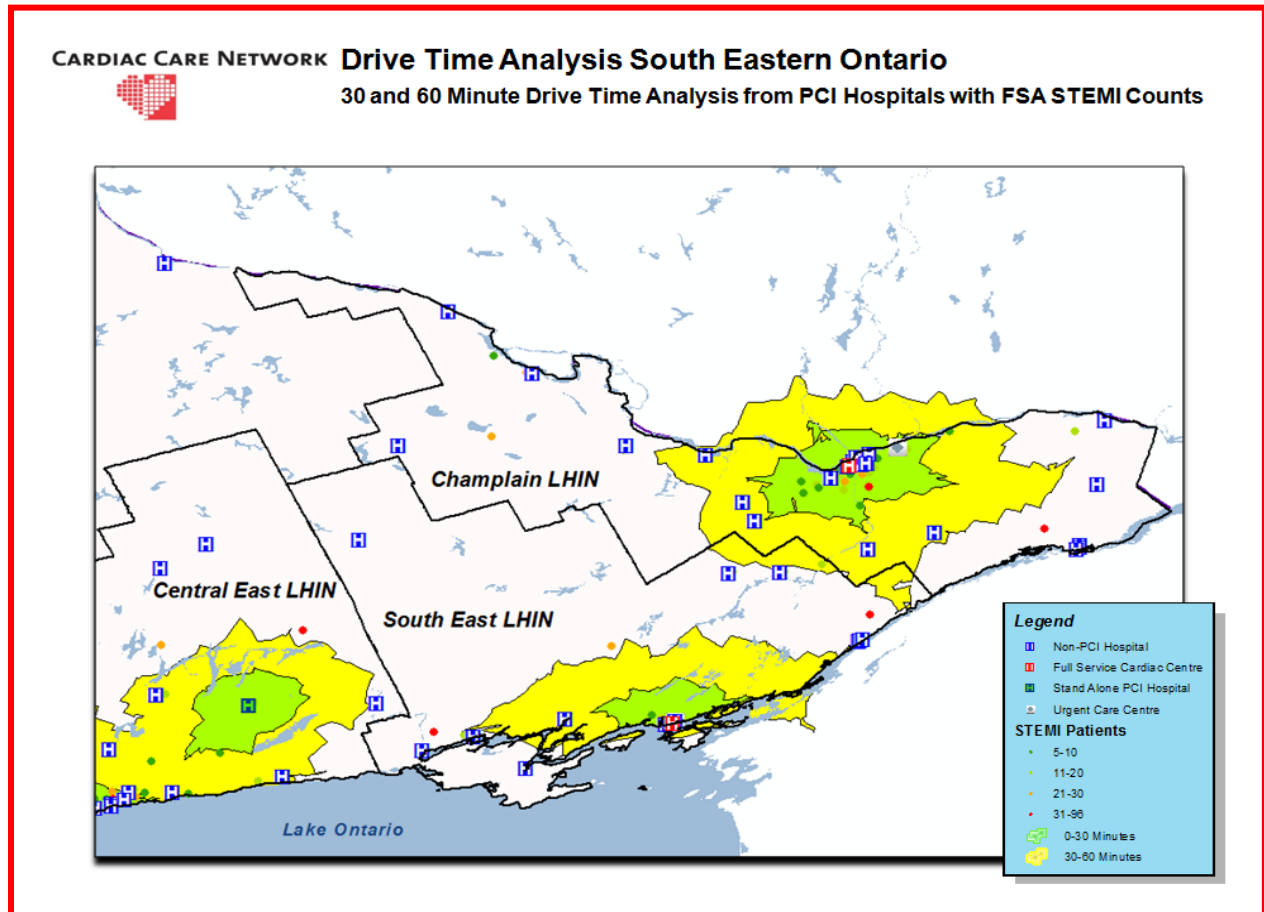
Figure 7: Distribution of STEMI patients within 30 and 60 minutes (by car) of a PCI Centre, GTA and Central Ontario, 2011/12



Source: CCN, using CIHI DAD, 2011/12



Figure 8: Distribution of STEMI patients within 30 and 60 minutes (by car) of a PCI Centre, South Eastern Ontario, 2011/12



Source: CCN, using CIHI DAD, 2011/12

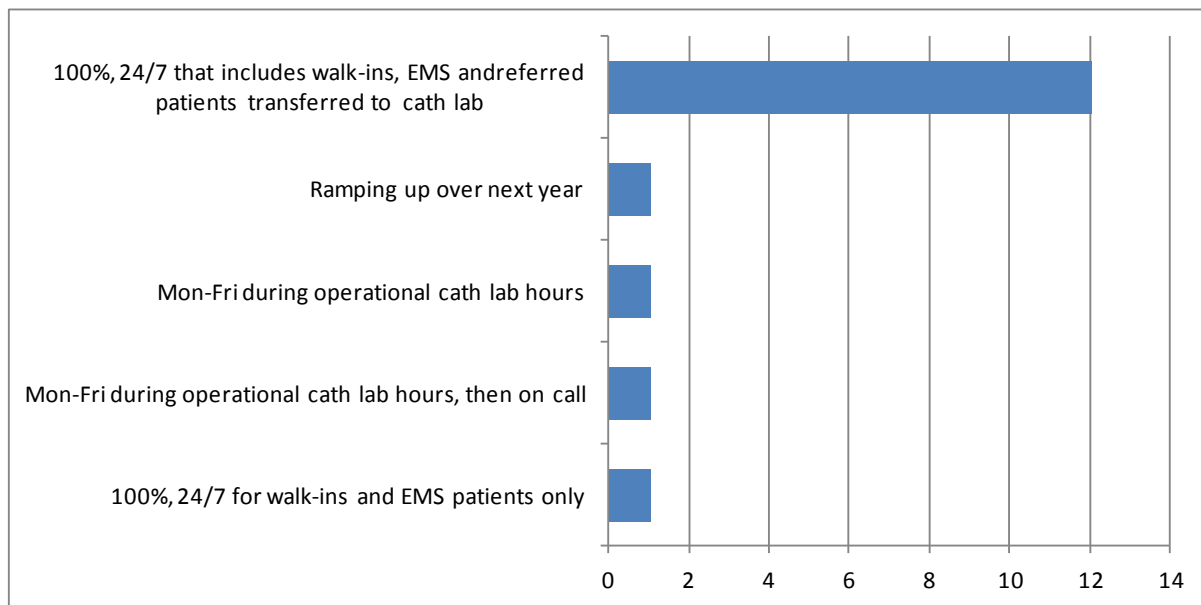
CCN collects data on PCI procedures, but does not receive reports on the number of STEMI patients who had fibrinolysis therapy and did not need to undergo PCI or cath after fibrinolysis therapy.

Availability of Primary PCI at a PCI Centre

The availability of primary PCI varies among PCI Centres. Twelve PCI Centres reported that they provide access to primary PCI 24 hours a day, seven days a week for patients who arrive on their own at a hospital (i.e., “walk ins”), from their home via EMS or by inter-hospital transfer, as shown in Figure 9. Two centres reported restrictions (e.g., access only during operational cath lab hours, access limited to walk-ins and EMS patients only).

All three centres that responded to the question about barriers to providing primary PCI 24/7 rated human resources as a major barrier (i.e., rated it as 5 or 6, where 6 is the most frequent barrier); two rated physical resources as 5 or 6; and two rated a lack of repatriation agreements with Referring Hospitals as 4.

Figure 9: What type of coverage does your hospital provide for STEMI patients requiring emergent PCI? (N=16)



Source: Question 8. PCI Hospital Survey, March 2012

1.9.5 Gap Analysis

The lack of comprehensive standardized data regarding the total number of STEMI in Ontario creates difficulties in estimating with confidence whether this patient population has access to appropriate and timely care.

Despite the importance of reperfusion for STEMI, available data suggest that the reperfusion rate varies significantly across Ontario. The inability to determine the total number of STEMI patients in Ontario in a given year frustrates efforts to accurately measure and monitor reperfusion rates for the province as a whole and by LHIN.

It is further suspected that a substantial proportion of STEMI patients are not treated (i.e., either with primary PCI or fibrinolysis therapy) within the recommended times. This finding could be attributed to either a lack of protocols for ensuring the timely diagnosis, transport and treatment (primary PCI or fibrinolysis) of STEMI patients or long travel times to PCI Centres. The Working Group recognizes that some degree of regionalization of services is needed to ensure each centre has a critical mass of patient volumes to maintain competence and achieve operational efficiencies. However, the regionalized nature of PCI services creates a need for protocols to expedite diagnosis, transport and treatment for STEMI patients.

Not all Referring Hospitals have STEMI protocols at this time; even where regional protocols exist, selection of reperfusion strategies varies from centre to centre within that region. Some rely on a prescriptive protocol provided by their regional PCI Centre while others use a point-of-care consult process. While a uniform strategy is optimal, the Working Group recognizes that STEMI networks can allow some regional variation as long as best-practice guidelines are followed.



1.9.6 Recommendations for Reperfusion Strategies

Based on best-practice guidelines, the Working Group recommends that primary PCI be the dominant strategy for reperfusion for STEMI in Ontario. In recognition of the specialized nature of primary PCI networks, the Working Group accepts that not all STEMI patients will be able to reach a PCI centre within the recommended times. Therefore, STEMI protocols are needed to ensure that:

- If the recommended timelines can be met, the patient should be referred for primary PCI.
- If the recommended timelines for primary PCI cannot be met, the patient should be given fibrinolysis, with a view to an early invasive strategy post fibrinolysis.

Priority Recommendation 1: That all PCI Centres, in collaboration with Regional Base Hospitals, Emergency Medical Services and Referring Hospitals in their catchment area, develop shared and common STEMI protocols to achieve timely access to reperfusion for all patients diagnosed as or suspected of having a STEMI. All Referring Hospitals should have a STEMI protocol with linkages to a PCI Centre.

The protocols should include options for antiplatelet and anticoagulant therapy and post-fibrinolysis management. They should also include protocols for cooling for cardiac arrest patients.

Priority Recommendation 2: That all PCI Centres, Emergency Medical Services and Referring Hospitals report every diagnosed STEMI case to the Cardiac Care Network of Ontario's cardiac registry, even if the patient is not referred for primary PCI.

1.10 Access to STEMI Diagnosis and Treatment in Remote Northern Communities

1.10.1 Current Practice

Approximately 30,000 residents live in Moose Factory and Sioux Lookout Zones. These areas have no EMS and rely on 28 nursing stations for pre-hospital triage and air ambulance for transport in the event of an emergency. Nurses are able to obtain vital signs and perform an ECG, although most ECGs are not able to provide automatic interpretation. Cardiac monitors, intravenous pumps, and automated external defibrillators (AEDs) are not available at all nursing stations, and nurses are not necessarily trained in Advanced Cardiac Life Support or how to use AEDs.

There is a need to standardize protocols for STEMI patients in these regions. The nurse assesses the patient, pages the physician on call and faxes the ECG results to the physician, who contacts the ED or intensive care unit (ICU) physician at the nearest acute care hospital to determine whether a bed is available. Air ambulance service typically takes between three and four hours or as long as 48 hours depending on the weather. STEMI patients are treated with conservative measures while awaiting transport to an acute care centre.

1.10.2 Gap Analysis

Access to primary PCI from some remote northern settings cannot currently be accomplished within the recommended timelines. However, many nursing stations have no access to fibrinolysis therapy onsite and, therefore, STEMI patients in these areas do not have any access to timely reperfusion.

1.10.3 Recommendations for Access in Remote Northern Communities

As noted earlier, all STEMI patients in Ontario should have timely access to appropriate care, no matter where they present. Patients in northern communities require special consideration, where optimal treatment is more likely delivered at nursing stations and an initial fibrinolysis strategy would be most appropriate for most patients.

Recommendation 3: That the Cardiac Care Network of Ontario STEMI protocols developed to ensure timely and appropriate diagnosis and management of STEMI patients for all remote communities be adopted as the standard of practice in Ontario, supported by Regional Base Hospitals, ORNGE, Emergency Medical Services, and PCI Centres and Referring Hospitals as well as primary care physicians.

1.11 Post-procedural Management of STEMI Patients

1.11.1 Best Practice

The Zwolle score and CADILLAC score are examples of indices developed for risk stratification of patients after primary PCI for STEMI that is used to identify low-risk patients who may safely be discharged home within 48 to 72 hours (De Luca, 2004; Halkin, 2005). Use of these tools can help PCI Centres optimize patient length of stay after primary PCI (Kotowytz, 2010).

Literature evidence regarding repatriation of STEMI patients post reperfusion suggests that it is feasible and safe in the majority of STEMI patients, allows for appropriate patient flow and helps utilization of limited hospital resources (Zia, 2008; Chan, 2011).

1.11.2 Current Practice

Length of Stay

All responding PCI Centres send primary PCI patients to a coronary care unit (CCU) or ICU post procedure. Three reported that they will send a patient to a telemetry or step-down unit depending on the patient's condition.

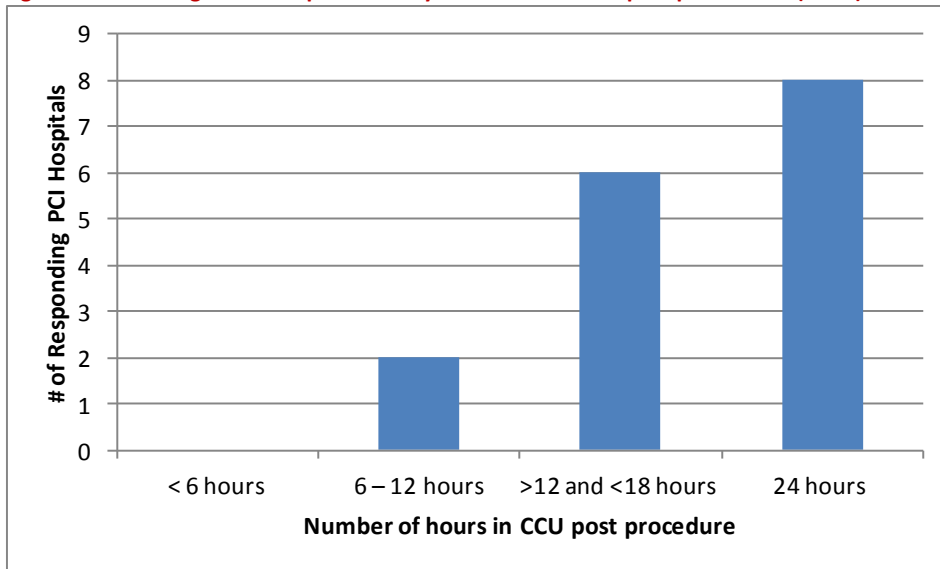
Practices for post-procedural management at PCI Centres vary considerably across the province on several dimensions:

- All PCI Centres reported that patients typically stay in a critical care bed longer than six hours post procedure; although eight reported that patients typically stay as long as 24 hours, as shown in Figure 10.



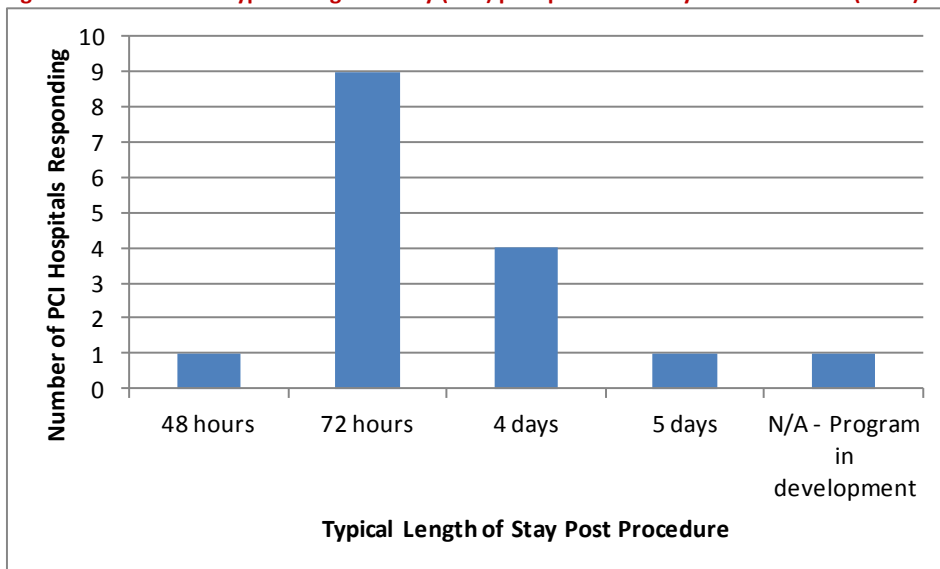
- The typical length of stay for a primary PCI patient post procedure can be as short as two days (two respondents) or as long as five days (two respondents). It is most often reported as 72 hours (nine respondents) or four days (four respondents), as shown in Figure 11.
- Only five (31%) of the 16 PCI Centres use a standardized early discharge scoring system (e.g., Zwolle) to facilitate timely discharge from hospital. One of the PCI Centres is currently establishing a scoring system. For patients that were repatriated to a non-PCI Centre post procedure, only one of 86 Referring Hospitals reported the use of any early discharge scoring system.

Figure 10: How long do STEMI patients stay in critical care bed post procedure? (N=16)



Source: Question 17. PCI Hospital Survey, March 2012

Figure 11: What is the typical length of stay (LOS) post procedure at your institution? (N=16)



Source: Question 19. PCI Hospital Survey, March 2012

All 16 PCI Centres reported that the following secondary prevention strategies are most commonly used:

- Acetylsalicylic acid (ASA).
- Anti-platelet therapy.
- Statins.
- Education on risk factor modification.

Fifteen of 16 PCI Centres reported that Angiotensin Converting Enzyme Inhibitor/Angiotensin Receptor Blocker (ACEi/ARB) therapy is commonly put in place, and 14 reported that referral to cardiac rehabilitation is part of their secondary prevention strategy.

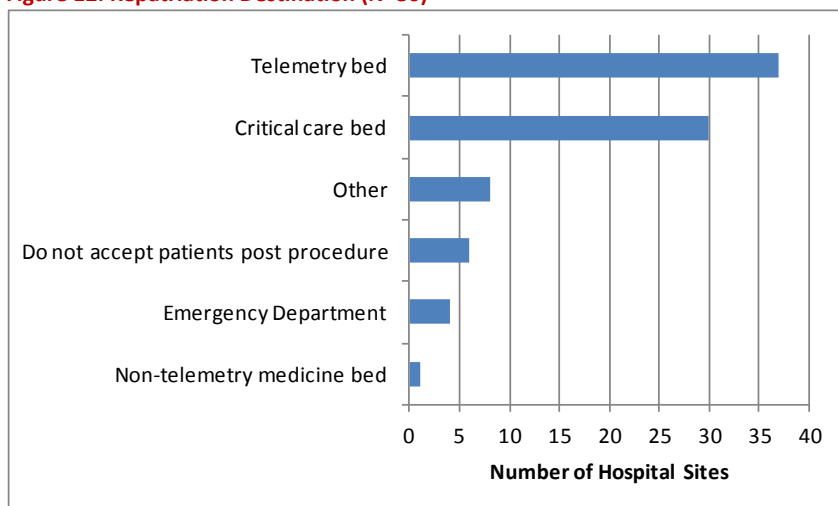
Repatriation

Patients who are transferred from a Referring Hospital or who bypass their nearest hospital are frequently repatriated after the procedure, in order to ensure that there are adequate bed resources at the PCI Centre to treat additional STEMI patients, and to ensure continuity of care for the patient from the Referring Hospital. Given the high annual STEMI volumes at some PCI centres, repatriation is a key component of care. Ten PCI Centres reported having formal repatriation agreements with the Referring Hospitals in their area; four reported that they have agreements with some Referring Hospitals; and two reported not having any repatriation agreements.

Those PCI Centres that do repatriate patients (one hospital reported that it does not due to distance) indicated that patients can be repatriated as quickly as less than six hours post procedure (one respondent) or as long as more than 16 hours post procedure (four respondents). Only five of the PCI Centres reported that they use early discharge scoring to facilitate repatriation⁸.

Patients are repatriated to a variety of destinations when they return to the Referring Hospital, and most commonly to a critical care (40%) or telemetry (37%) bed, as shown in Figure 12.

Figure 12: Repatriation Destination (N=86)



Source: Question 24. Non-PCI Hospital Survey, March 2012

⁸ These are the same hospitals that reported using a scoring system to facilitate early discharge.



Eleven of the responding PCI Centres reported that the availability of telemetry and critical care beds were the most frequent barriers to repatriating patients to a Referring Hospital, with 11 (85%) rating these barriers as “3”, “4” or “5”, where “5” is the more frequently occurring, as shown in Table 3. Resources for inter-hospital transfers were also cited as a frequent barrier (53% ranked as “3”, “4” or “5”). Responses from Referring Hospitals were entirely consistent with the responses of the PCI Centres, as shown in Figure 13.

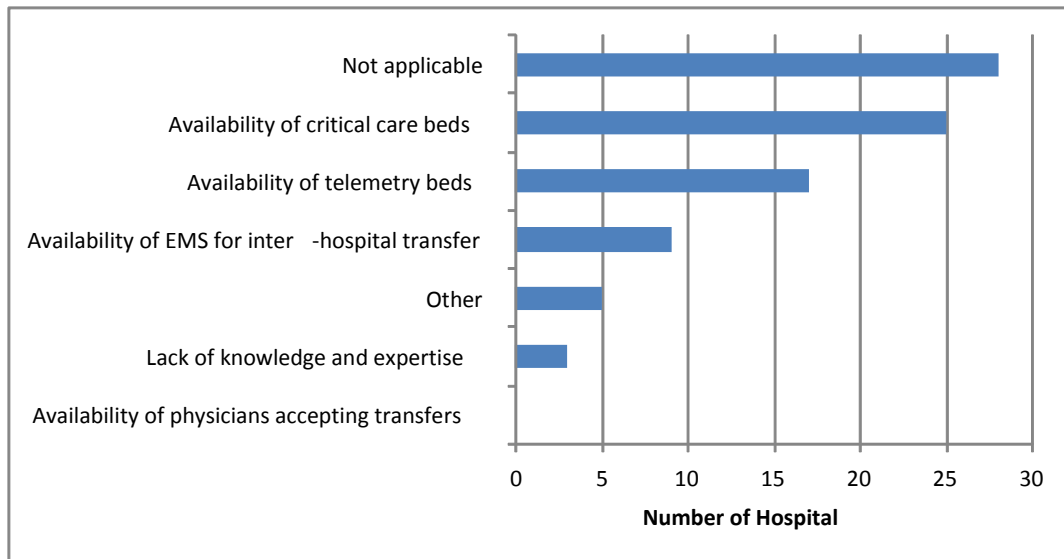
The lack of repatriation agreements with Referring Hospitals was cited as a barrier to providing primary PCI on a 24/7 basis, given the intensive care and monitored bed pressures at the PCI Centres.

Table 3: Please rank the following barriers to repatriating patients post PCI in order of most frequently occurring (5) to least frequently occurring (1). (N=14)

Response Options	Response Count	Ranked 4 or 5		Ranked 3, 4 or 5	
		(#)	(%)	(#)	(%)
Availability of telemetry beds	13	11	85%	11	85%
Availability of critical care beds	13	8	62%	11	85%
Availability of EMS for inter-hospital transfer	15	3	20%	8	53%
Availability of physicians accepting transfers	9	2	22%	3	33%
Lack of knowledge and expertise of post PCI patients’ management	14	0	0%	4	29%

Source: Question 25. PCI Hospital Survey, March 2012


Figure 13: Most Frequent Barrier to Accepting Post PCI Patients (N=87)



Source: Question 27. Non-PCI Hospital Survey, March 2012

1.11.3 Gap Analysis

PCI Centres are often not able to accept a patient unless there is an agreement that the patient will be accepted by the Referring Hospital after the procedure. All Referring Hospitals should have some form



of repatriation agreement with the nearest PCI Centre to ensure timely acceptance of all STEMI patients for primary, rescue or pharmacoinvasive PCI.

1.11.4 Recommendations for Post-procedural Patient Management

Memoranda of understanding (MOUs) and repatriation agreements take considerable time and effort by EMS and hospital staff to develop, implement and monitor to ensure the terms of the agreements are considered in day-to-day practice. A provincial strategy with a standardized approach to such agreements would promote and streamline access to urgent PCI across Ontario.

Recommendation 4: That the Cardiac Care Network of Ontario develop a standard provincial inter-hospital agreement for the acceptance and repatriation of STEMI patients between Referring Hospitals and PCI Centres that can, in collaboration with Local Health Integration Networks and local health service providers, be adapted to local circumstances. The Ministry of Health and Long-Term Care is asked to mandate the use of these templates. Where current protocols exist for repatriation (e.g., stroke patients), the agreements could be adapted to include STEMI patients.

Recommendation 5: That the Cardiac Care Network of Ontario develop criteria for standardized discharge and repatriation practices that can be adapted for local use by all institutions that treat STEMI PCI patients, in collaboration with their local PCI provider.

These recommendations should be implemented at the local level as one component of a regional STEMI network.

The Working Group does not recommend a particular time for repatriation. Each PCI Centre should establish repatriation practices based on individual assessment, and should provide for repatriation typically within 24 hours post procedure.



Timely Care

The ACC/AHA STEMI update of 2009 states *“the focus should be on developing systems of care to increase the number of patients with timely access to primary PCI rather than extending acceptable window for door to balloon time”*. (Kushner, 2009)

As noted in the introduction to the previous chapter on appropriate care, timeliness of care for STEMI patients is measured in minutes, not days or weeks. The ACC/AHA guidelines recommend that STEMI patients treated by primary PCI presenting to a PCI capable hospital have a D2B time of less than 90 minutes and patients treated with fibrinolysis therapy have a door-to-needle (D2N) time of less than 30 minutes; patients presenting to a non-PCI capable hospital should have a D2B time of less than 120 minutes (ACC/AHA 2011)⁹.

While the previous section discussed the clinical necessity for timely intervention, this section of the report considers the processes and protocols required to ensure that the time to treatment is optimized. From the time of symptom onset until the patient has undergone reperfusion, the patient could have had contact with up to four different health service providers (e.g., EMS, Referring Hospital ED, PCI Centre ED, PCI Centre cath lab), as shown in Figure 14. Accordingly, protocols for the timely and accurate diagnosis of STEMI are necessary to ensure that all those who require primary PCI are identified, triaged and transported through the health care system as quickly as possible. These strategies should focus on ensuring the patient moves along the preferred route to care (shown as a solid green line in the diagram), as well as along other routes (e.g., from the ED of a Referring Hospital to fibrinolysis therapy or to the PCI Centre’s cath lab).

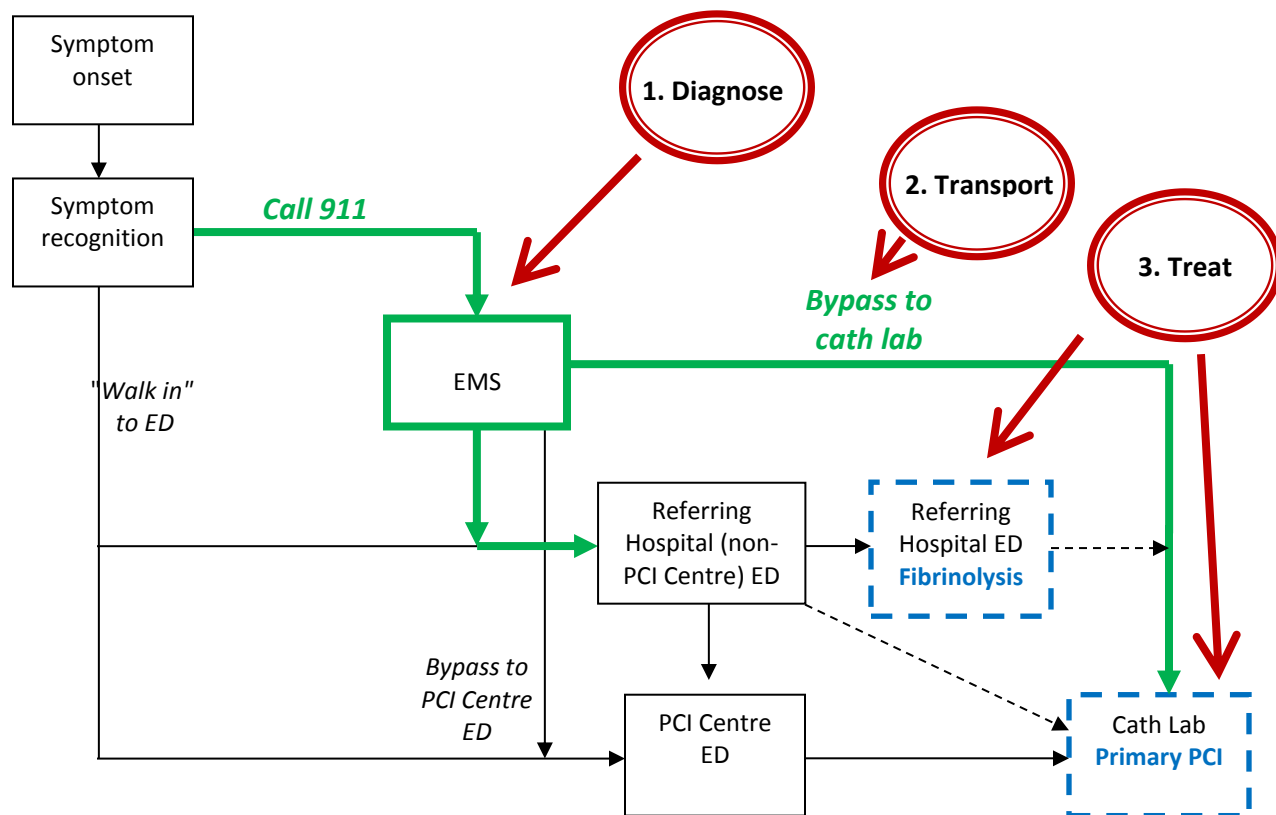
Three strategies have been identified to optimize the time from symptom onset to treatment (either primary PCI or fibrinolysis therapy) as follows:

- Diagnose the patient as early in the patient flow as possible (e.g., enable EMS to diagnose STEMI patients).
- Adopt protocols to ensure the shortest time to the treatment site and to treatment once the patient is on site (e.g., EMS bypass protocols to allow them to go directly to the PCI Centre).
- Ensure real-time exchange of patient data between health service providers to facilitate rapid clinical assessment and treatment.

A fourth strategy would be to raise awareness among the general population to shorten the time from symptom onset to when the patient calls 911 or goes to an ED.

⁹ Door-to-needle (D2N) time is the elapsed time from when the patient arrives at the emergency department until the fibrinolysis therapy is initiated. Door-to-balloon (D2B) time is the elapsed time from when the patient arrives at a PCI or non-PCI hospital until the first balloon is inflated to restore blood flow to the heart.

Figure 14: Simplified System Flow of STEMI Patients



Heavy green lines show fastest route to treatment (i.e., urgent PCI or fibrinolysis)
 Dashed blue boxes show treatment sites

1.12 Timely Diagnosis of STEMI Patients

The success of treating patients with STEMI is dependent on appropriate patient selection and timely treatment (CCN, 2004). Accordingly, it is extremely important to identify STEMI patients as quickly as possible (timely and reliable diagnosis), and then to treat them as quickly as possible with the appropriate intervention.

1.12.1 Best Practice in Diagnosis

Early recognition of STEMI allows for rapid therapeutic intervention, which is closely linked to survival and reduced adverse cardiac outcomes (GUSTO-IIb, 1999; Nallamothu, 2003).

Diagnosis of a STEMI is by ECG, a non-invasive diagnostic test that measures electrical activity through electrodes attached to the patient's chest to record the overall rhythm of the heart and weaknesses in different parts of the heart muscle. The ECG performed at the time of first medical contact after symptom onset, whether by EMS, in the ED or in a physician's office, permits rapid triage to an optimal reperfusion strategy.

To limit the risk of delay in interpretation, multiple methods can be used to identify STEMI:



- Automated ECG interpretation.
- ED nurse or paramedic trained in STEMI identification.
- ED physician.

Diagnosis by EMS

Paramedics with the appropriate training can successfully interpret 12-lead ECGs to identify STEMI patients in the field (Le May, 2006). Literature shows that treatment times are superior for STEMI patients who are diagnosed pre-hospital (e.g., by paramedics) (Cheskes, 2011). A more recent study concluded that patients suspected of having STEMI could be transported by paramedics without advanced care training (Cantor, 2012). A third study (Verbeek et al, 2012) found that multiple pre-hospital ECG's were superior to a single pre-hospital ECG.

The 2009 STEMI and PCI Guidelines (Kushner, 2009) include a Class I recommendation for triage as follows:

"Each community should develop a STEMI system of care that follows standards at least as stringent as those developed for the AHA's national initiative, Mission: Lifeline, to include ... a process for prehospital identification and activation."

The ACCF/AHA 2013 STEMI Guidelines (O'Gara et al, 2013), note that EMS personnel should perform an ECG on arrival at the scene if the patient's symptoms suggest STEMI. These guidelines also indicate that EMS is the preferred activation point for STEMI; however, this is only possible if the patient calls 911. The patient will have more timely access to primary PCI if EMS can activate the cath lab and deliver the patient to the PCI Centre rather than to the nearest ED.

Diagnosis in the ED

All patients presenting to an ED with chest discomfort or other symptoms suggestive of STEMI should be considered high-priority CTAS level 2 (emergent)¹⁰. All patients presenting to an ED with suspected STEMI should have immediate clinical evaluation and investigation to establish the diagnosis and determine eligibility for primary PCI.

A 12-lead ECG should be performed and shown to a health professional who has the authority to activate a reperfusion strategy within 10 minutes of ED arrival for all patients with chest discomfort (or anginal equivalent) or other symptoms suggestive of STEMI (AHA 2009 Class 1 LEC). When the patient arrives by EMS, the results of the EMS ECGs should be left with the patient in the ED (Jolis, 2010).

Timely assessment of STEMI should include protocols for the following:

- ECG acquisition in the ED in under 10 minutes from arrival at the ED.
- Serial ECG in suspicious cases (5 to 10 minutes apart).

¹⁰ The Canadian Triage & Acuity Scale (CTAS) is a tool that enables EDs to prioritize patient care requirements. The CTAS National Working Group guidelines, which are used in all hospitals in Ontario, assign a triage level of CTAS level 2 for chest pain.

In the ED, a targeted history should be taken and a brief, focused physical examination of patients should be performed to aid in the diagnosis and assessment of the extent, location and presence of complications of STEMI.

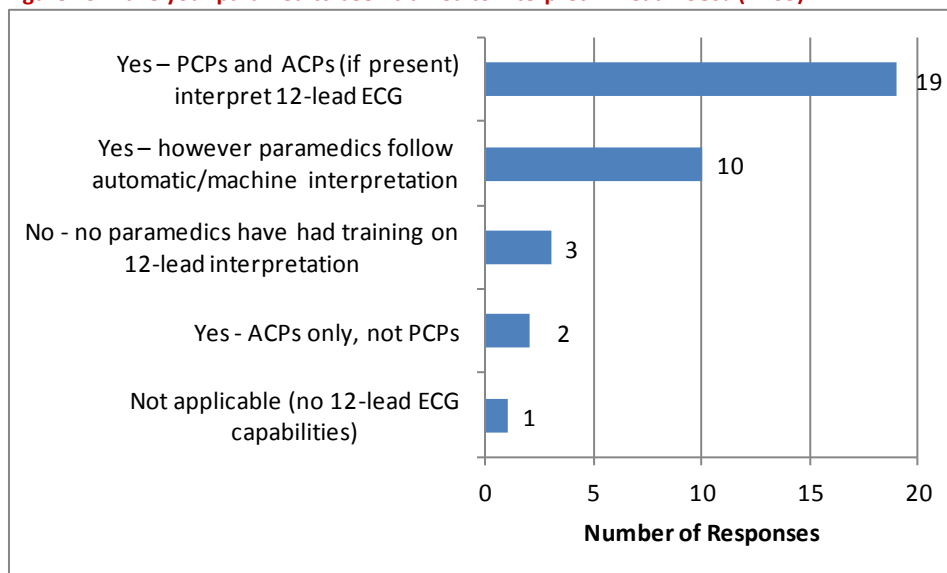
The same standards should apply across all hospitals (Antman, 2008; Miedema, 2011).

1.12.2 Current Practice in Diagnosis

Current practice¹¹ in many EMS jurisdictions in Ontario is for paramedics to use 12-lead ECGs when STEMI is suspected, although this equipment is not currently mandatory for EMS in Ontario. Thirty EMS out of 35 (86%) responded that they have 12-lead ECG on all vehicles, and 29 EMS (83%) indicated that primary care paramedics (PCPs) are trained to identify STEMI in the field.

The two EMS that reported having no vehicles equipped with 12-lead ECG were in the Northeast and the Northwest; both reported lack of Regional Base Hospital support as a contributing factor. Follow up on the survey results suggests that the barrier is the need for training and funding for that training. Only three of the EMS that reported having 12-lead ECG capability reported that their paramedics have no training, as shown in Figure 15.

Figure 15: Have your paramedics been trained to interpret 12-lead ECGs? (N=35)



Source: Question 12. EMS Survey, June 2012

Of the 30 EMS that reported allowing paramedics to diagnose STEMI in the field, 18 reported that they give pre-hospital notification to the interventional cardiology team of inbound STEMI patients, and 17 reported that the cath lab team is activated by paramedics from the field after hours.

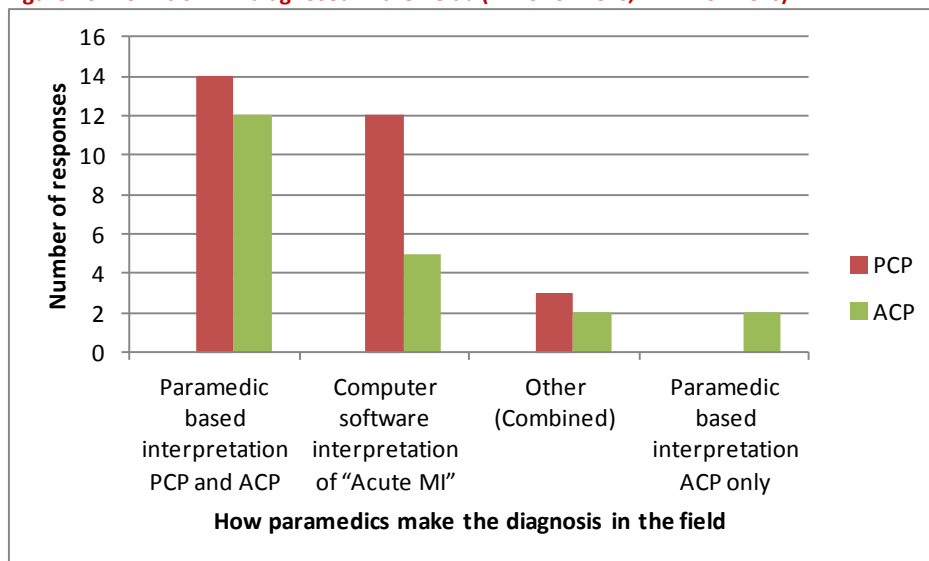
¹¹ As noted earlier, 35 of the 56 EMS in Ontario responded to the Working Group's survey. Therefore, the results of the survey as presented below represent 63% of the services and may not provide the full picture of EMS practices across the province.



Twenty EMS (66%) reported having STEMI protocols in place, although there is a great deal of variation in the protocols for the identification of STEMI patients by paramedics across the province:

- Fourteen services reported that PCPs are allowed to diagnose STEMI in the field based on their interpretation of the ECG; another 12 relied on computer software interpretation; and three reported a combination of these approaches. (See Figure 16)
- More than one-half (12/21) of the services that allow advanced care paramedics (ACPs) to diagnose STEMI allow them to use their own interpretation of the ECG.
- When STEMI is diagnosed in the field, 12 EMS responded that all patients are transferred to the nearest ED for fibrinolysis, seven transfer patients directly to a cath lab for primary PCI, and 10 have a hybrid model (e.g., depending on distance from nearest PCI Centre).

Figure 16: How is STEMI diagnosed in the field? (N=29 for PCPs, N=21 for ACPs)



Source: Questions 18 & 19. EMS Survey, June 2012

Diagnosis in the ED

Approximately 61% of STEMI patients arrive at either a Referring Hospital or a PCI Centre via ambulance and 3% are in-hospital transfers. The remainder (36%) are patients who “walk in” to an ED and are then diagnosed with STEMI. Walk-in patients have delays in diagnosis and treatment compared to patients who present by EMS (Mercuri, 2010)

All EDs in the province are required to have 12-lead ECG capability. Among the 86 Referring Hospitals sites that responded to the question of whether they had an ED physician on site 24/7, 70 (81%) responded that they did. Sixty-nine of 90 (77%) reported that they have a STEMI protocol in place. EDs that do not have a 24/7 physician on site should ensure that the nursing personnel is able to analyze a 12-lead ECG. STEMI protocol should outline actions required by the nurse to streamline either PCI Centre activation or timely administration of fibrinolysis.

All PCI Centres have STEMI protocols.

1.12.3 Gap Analysis

The 12-lead ECG is used as the primary diagnostic tool for STEMI by EMS and in EDs across the province. However, not all EMS have the equipment (i.e., 12-lead ECG machines), the training or access to continuing medical education to maintain competence in performing and interpreting the ECG to complete this test. Only 66% of the responding EMSs had a STEMI protocol in place, and the role of paramedics in diagnosing STEMI varies across services.

STEMI protocols are in place at most (81%), but not all, Referring Hospitals.

1.12.4 Recommendations

Diagnosis by EMS

The timely and accurate diagnosis of STEMI is necessary to ensure that appropriate reperfusion therapy can be delivered in a timely manner.

Protocols should be developed to specify how the ECG interpretation would be conducted (e.g., paramedic interpretation, machine confirmation of STEMI, transmission to an ED physician or interventionalist, combination of these approaches). The protocols should vary depending on the skill level of the attending paramedic for ECG acquisition and interpretation (e.g., PCP vs. ACP), which will be influenced by how frequently the paramedics have an opportunity to apply these protocols.

Priority Recommendation 6: Ensure that the appropriate infrastructure is in place in Ontario to support timely diagnosis for STEMI patients through the following investments:

- Ensuring that all ambulances and emergency response vehicles in Ontario are equipped with cardiac monitors capable of 12-lead ECG acquisition and ensuring the development of processes for informing the nearest cardiac centre or emergency department of the results.
- Supporting the existing provincial paramedic education program for ECG acquisition and STEMI identification for all paramedics.
- Supporting Regional Base Hospitals to develop a standardized annual education program to ensure ongoing competency in ECG acquisition skill.

Diagnosis in the ED

With approximately 36% of patients presenting by self-transport to an ED, it is difficult to achieve timely diagnosis and treatment if the time between symptom onset and arrival at the ED is already long. Public awareness initiatives are needed to educate the public about the importance and availability of timely treatment and that calling 911 can be lifesaving (compared to presenting directly to an ED). Once the patient arrives at an ED, protocols are needed for timely diagnosis and treatment.



Recommendation 7: That every emergency department and urgent care centre in Ontario, in collaboration with the nearest PCI Centre, Regional Base Hospital and Emergency Medical Services, establish a multidisciplinary team (including emergency medicine physicians, cardiologists and nurses) to develop guideline-based, institution-specific, written protocols for triaging and managing patients suspected of or diagnosed as having STEMI.

These guidelines should include protocols for the following processes:

- Early chest pain triage and a process for immediate evaluation.
- Rapid ECG access and interpretation.

The development of these protocols must also take into consideration the resource impacts of these protocols such as the availability of triage nurses, ECG equipment capacity and human resources to conduct and interpret the test, physician awareness of the protocols and the importance of meeting the recommended target times.

There should also be a feedback mechanism on the accuracy of the diagnoses made using these protocols to support process improvement.

1.13 Time to Treatment

Once the patient has been diagnosed as having a STEMI, the patient should be treated with primary PCI or fibrinolysis therapy as quickly as possible. Timely access to reperfusion depends on streamlined processes for:


- Activation of the primary PCI team.
- Bypass to the closest PCI Centre or timely transfer from the Referring Hospital ED to the cath lab.
- Protocols within the cath lab to optimize the time from arrival at the cath lab to reperfusion.

1.13.1 Activation

Best Practice

When STEMI is suspected or has been diagnosed, all service providers must recognize the need for timely transportation and treatment. The receiving cath lab must be notified of the incoming patient (i.e., "activated"), particularly if a primary PCI team needs to be called in (e.g., after hours). Major causes for delay in activation and transport of patients include awaiting transport, ED delays, non-diagnostic initial ECG and complicated cases requiring additional consults and diagnostic tests (Miedema, 2011).

The initial diagnosis of STEMI relies on symptoms and the 12-lead ECG results. A single ECG demonstrating ST-segment elevation patterns signifies the presence of coronary occlusion and the need for immediate reperfusion with primary PCI or fibrinolysis. However, there are several situations in which the ECG changes may mimic myocardial infarction and not be associated with coronary occlusion (e.g., pericarditis, early repolarization), or the ECG changes may be over-interpreted by emergency



personnel and frontline physicians leading to inappropriate or avoidable activation of the primary PCI team or administration of fibrinolysis. This over activation can range from 5% to 25% of cases across different STEMI networks, and there is variability based on whether the STEMI activation was performed by the EMS personnel, physician at a non-PCI site or physician at a PCI site. Historically, these scenarios have been labeled in the literature as "false positive" STEMI diagnoses or "inappropriate" activation.

Inappropriate activation may result in harm due to:

- a) Inappropriate care of the patient (e.g., complication of administration of a therapy when not indicated, performance of an unnecessary procedure and lack of consideration of alternative diagnosis and treatment).
- b) Increased or inappropriate use of human and physical resources.
- c) Unnecessary delay and risk due to cancellation or postponement of other booked elective and urgent cases.
- d) Risk to the community and emergency personnel due to the need to drive rapidly to hospital.
- e) Increased costs.

It is being increasingly recognized that using the terms "false positive" or "inappropriate activation" or "over activation" in isolation is not useful since, in some cases, EMS or the sending physician follows the protocol and activates the system appropriately; however, the interventionalist makes a different diagnosis that could not have been predicted based on patient symptoms or ECG findings alone (e.g., takotsubo¹²). Therefore, the confirmation of STEMI diagnosis is based on synthesis of clinical presentation (symptoms and signs), ECG findings, angiographic findings and cardiac biomarkers.

What is "acceptable" as a trigger to activate the cardiac catheterization team for emergency catheterization continues to evolve. Sometimes, not all parameters to confirm STEMI diagnosis may be available as the patient may die prior to intervention, the ECG may resolve or the patient may refuse intervention. Also, emergency cardiac catheterization may still be performed in the absence of clear STEMI findings or appropriate activation as the team was already called in, and there is variability in how programs define an emergency cath or PCI procedure as being appropriate or inappropriate.

While direct transfer from the field by EMS to the cath lab without ECG transmission to a physician may result in a higher number of false STEMIs, it does provide for the most timely and consistent access to primary PCI. When the level of false STEMI PCI lab activations exceeds the proposed benchmarks, the impact on cath lab staff may become a significant issue to the sustainability of such systems. Quality assurance and provider feedback are important to ensure that false positive rates of cath lab activation meet acceptable benchmarks (Bradley et al, 2006) (Ting et al, 2008).

In a survey of 365 hospitals in the US, six strategies for cath lab activation were found to be independently associated with improved times:

1. ED activation of the cath lab (e.g., protocols to accept patients directly to the cath prior to obtaining a critical care bed). This strategy was included as a recommendation in the CCN report.

¹² A non-ischemic cardiomyopathy in which there is a sudden temporary weakening of the heart muscle.



2. A single call system. The use of a Code STEMI system approach to mobilize teams has been further proven in two recent studies (Clark, 2012; Le May, 2008).
3. Early arrival of cath lab teams (e.g., in less than 30 minutes).
4. Data monitoring and feedback. This could include, for example, a feedback loop for false positives in a quality assurance program.
5. Administrative support for primary PCI networks.
6. System-wide team-based approach from EMS to the cath lab.

Current Practice

The protocols for activation of the cath lab varied considerably across the province:

- For primary PCI, only nine of the 16 PCI Centres reported that the cath lab team is activated through a centralized call system directly from the field or ED (i.e., without consultation with an interventionalist or a cardiologist). Most other PCI Centres (seven of 16) activate the team only after discussion with the ED physician, EMS paramedic or on-call interventionalist.
- For rescue PCI, eleven of 14 PCI Centres activate the cath lab team for rescue PCI only after discussion with the ED physician.
- For pharmacoinvasive treatment, only two PCI Centres activate the team through a centralized call system from the ED (without consult). Most (nine of 15) activate only through the interventionalist on call after discussion with the ED physician.


Gap Analysis

Although delayed cath lab activation has been shown to contribute to major delays in the time to treatment for STEMI patients undergoing primary PCI, not all EMS and EDs have protocols in place to ensure timely activation.

Recommendations for Timely Activation

Once a diagnosis of STEMI has been made, an organized approach to responding in an acceptable timeframe is needed. This response must be coordinated across the full health care system including EMS, Referring Hospitals and PCI Centres, each of which requires a code STEMI protocol and criteria for the activation of the code.

Priority Recommendation 8: That all Emergency Medical Services establish, in collaboration with area hospital emergency departments, Regional Base Hospitals and the nearest PCI Centre, activation protocols to minimize delays in the acceptance of the patient for primary PCI and arrival of the cath lab team.



Such a coordinated response would include four elements to be developed as part of the activation requirements for in-hospital management:

1. Development of a code STEMI protocol for each EMS, Referring Hospital and PCI Centre.
2. Activation of a code STEMI in a PCI Centre.
3. Activation of a Code STEMI in a Referring Hospital.
4. Activation of a Code STEMI from the field (EMS).

The protocols should also address the need for clear communication protocols, facilitated by the sharing of clinical data to ensure that the patient is transported to the nearest available PCI Centre and that only one centre is activated when a STEMI code is called.

For patients diagnosed with STEMI who arrive at a PCI Centre, the cath lab team should be activated with direct notification from the hospital's ED with an in-house Code STEMI ED. The Code STEMI ED should include a process for direct patient transfer to the cath lab on a priority basis (e.g., dedicated porters).

The time from the ED "door" to the cath lab should be monitored and reported regularly to assist in the identification of potential process improvements and efficiencies in patient flow to optimize the D2B time. In addition, all EDs should work to minimize the door-in door-out (DIDO) times for STEMI patients in the ED.

To address the issues associated with inappropriate cath lab activations, to facilitate constructive feedback and to have a standard reporting platform across the province, the Working Group felt that it is useful to define, measure and monitor the processes of diagnosis and activation and divide these into three considerations:

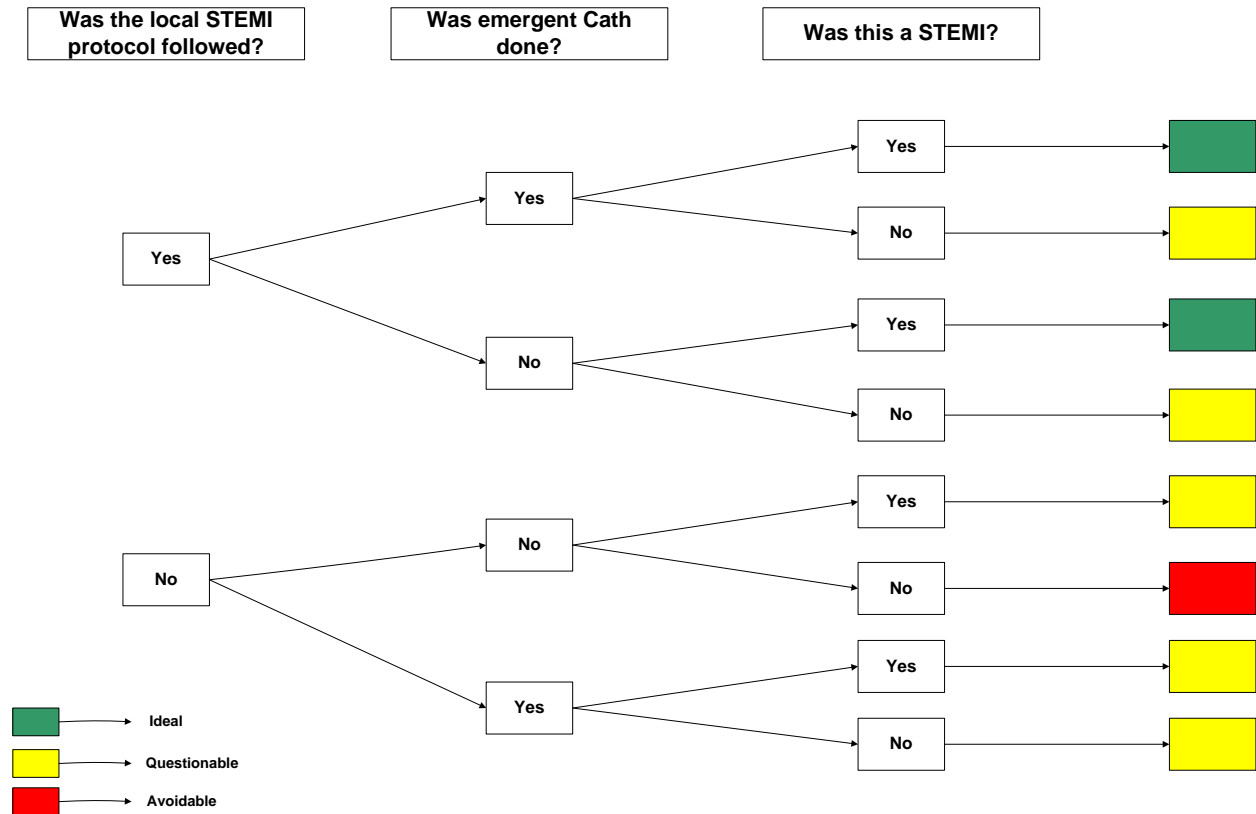
- a) Was cardiac catheterization performed emergently?
- b) Was diagnosis of STEMI confirmed?
- c) Did the patient meet all STEMI activation criteria as per local practice guidelines?

These processes can be summarized and reported to providers using a schematic as detailed in Figure 17.



Figure 17: STEMI Activation Log: Proposal for a 3 Step Checklist Process

STEMI Activation Log: Proposal for a 3 Step Checklist Process



1.13.2 Bypass

Once the patient is diagnosed as having a STEMI, it is important, whenever feasible, to transport the patient to the closest PCI Centre for primary PCI. EMS is mandated by the Ambulance Act to take the patient to the "closest most appropriate hospital" using an "approved local bypass guideline"; therefore, for STEMI patients, a special agreement is needed to allow EMS to "bypass" the nearest ED and proceed straight to the nearest PCI Centre.

Best Practice in Bypass

A recent study in Ontario found that allowing EMS to transport STEMI patients directly to a primary PCI Centre was associated with a significant reduction in mortality (Le May, 2012). The ACCF/AHA 2013 STEMI Guideline's (O'Gara et al, 2013) recommended triage strategy for STEMI patients is direct EMS transfers as long as the 90 minute D2B time is achieved from first medical contact.

Literature suggests that bypass directives based on the efficiency of hospital processes may be more effective than directives based solely on geography (Clark, 2012).

Once a patient has been diagnosed with or suspected of having a STEMI, the preferred intervention is primary PCI, but only if the EMS to balloon time (E2B) will be within 90 minutes. However, EMS diversion from a closer hospital that lacks interventional facilities to a PCI Centre is not supported for longer travel times, unless the patient has other characteristics that favor PCI such as contraindications to fibrinolysis therapy or cardiogenic shock (Jolis, 2010; Antman, 2008).

In theory, the maximum transport time can be flexible, as long as the time to balloon is expected to be within 90 minutes. In practice, however, there is a risk that the patient's condition will deteriorate while being transported, and the paramedics on board may not have the medical skills or equipment to manage the patient's condition. The longer the patient is in transit, the greater the risk for an adverse event.

At this time, there is little literature to support a single maximum transport time. The current STEMI guidelines support a maximum drive time of 30 minutes (Studnek et al, 2010).

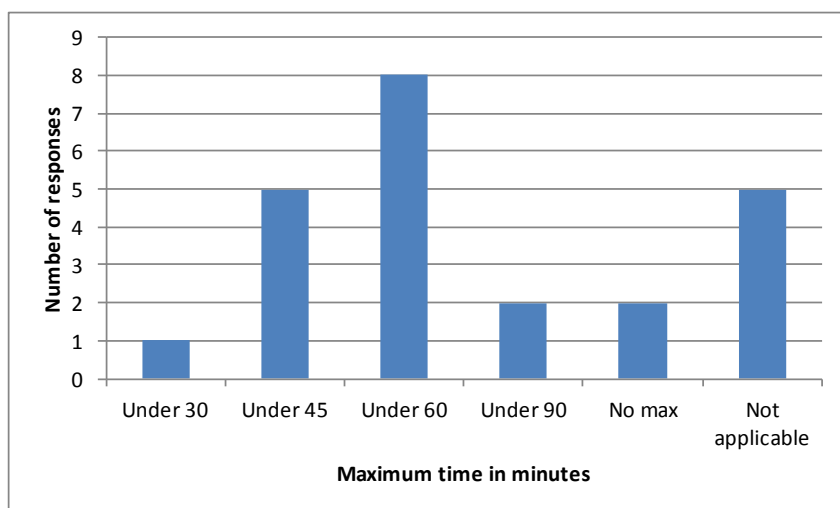
For inter-hospital transfers, a physician in the Referring Hospital has assessed the patient's condition and determined whether the patient can safely be transported. Accordingly, the allowable time to balloon is slightly longer (i.e., 120 minutes), allowing for a longer transport time.

Current Practice in Bypass

In Ontario, the receiving PCI Centre is usually a single centre within the EMS jurisdiction, which requires that the ambulance operate under "bypass" protocols. Based on the EMS Survey responses, there is a great deal of variation in the transportation protocols across the province:

- One EMS reported a maximum drive time from scene to PCI Centre of under 30 minutes, and two reported a maximum of under 90 minutes. The most frequent response (eight EMS) was under 60 minutes, as shown in Figure 18.
- Contraindications to transfer are also inconsistent across the province (e.g., different blood pressure values, access dependent on hours of operation).

Figure 18: Maximum drive time in minutes allowed by protocol from scene to PCI hospital (N=23)



Source: Question 16. EMS Survey, June 2012



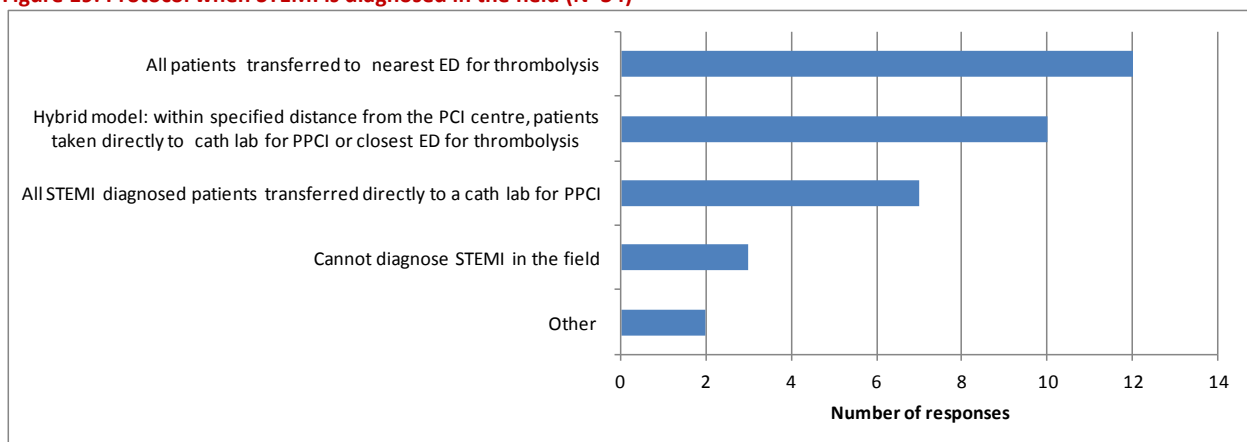
Several EMS jurisdictions in Ontario are currently using a maximum drive time of 45 minutes with PCPs or ACPs without adverse events, and Working Group members felt patient safety was optimized during this window, although continuing research in Ontario may lead to greater comfort with longer drive times (e.g., 60 minutes).

Of the 20 EMS that reported barriers to creating a STEMI bypass protocol, 14 (70%) reported that the distance was too great to reach a PCI Centre, three reported financial barriers, two reported legal barriers, and other EMS reported challenges in securing equipment or technology, human resources or training to support a bypass protocol.

Of the 27 EMS that responded to the question about having a Memorandum of Understanding (MOU) with a PCI Centre, 11 (41%) did not have one with any PCI Centre. Only seven EMS reported having a system or agreement in place with bordering municipalities when STEMI patients need to bypass acute care hospitals and be transferred across municipal borders.


When STEMI is diagnosed in the field, protocols for transport vary across the province, as shown in Figure 19.

Figure 19: Protocol when STEMI is diagnosed in the field (N=34)



Source: Question 22. EMS Survey, June 2012

The use of STEMI bypass directives are not explicitly addressed in the Ambulance Act but can be covered under the development of an approved bypass guideline as per the Basic Life Support (BLS) standards. A province-wide stroke bypass protocol has been in use in Ontario for approximately eight years using a bypass guideline. The success of the stroke bypass protocol may serve as a precedent for the development and implementation of a provincial STEMI bypass directive. There would be value in integrating the bypass directives with those for stroke, trauma and renal dialysis to streamline the protocols for the bypassing of patients to the most appropriate facility.



The adoption of a STEMI bypass protocol would require the approval of the Ontario Base Hospital Group (OBHG) Medical Advisory Committee (MAC). The OBHG MAC would likely approve a province-wide bypass directive if:

- The protocols were based on evidence (to the degree possible).
- All jurisdictions were to adopt a consistent format for their directives, with the ability to have some element of local variation as necessary.

Gap Analysis

Although the literature supports the use of bypass protocols to ensure timely transport of STEMI patients directly to the receiving cath lab, such protocols are not in place in all EMS in Ontario. Where they are in use, the protocols are not standardized across the province.

Recommendations for Bypass and EMS Transfer Times

Bypass Protocols

If 12-lead ECG capability were available in all jurisdictions (see recommendation 6), the next step would be to enable paramedics to transport patients with STEMI to the closest PCI Centre. Rapid transport by EMS, with rapid transfer to a cath lab or a dedicated STEMI assessment bed that is ready to receive the patient, bypassing the receiving PCI Centre's ED, will shorten the time to reperfusion and improve patient outcomes.

Similarly, walk-in STEMI patients assessed in the ED should be expedited to a cath lab with a directed STEMI protocol.

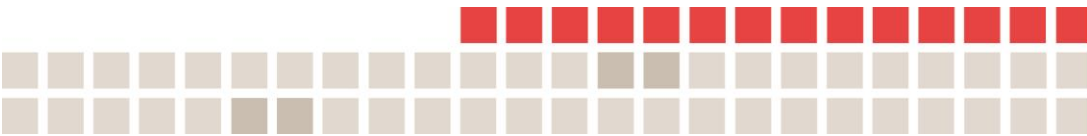
Recommendation 9: That all Emergency Medical Services, in collaboration with the Cardiac Care Network of Ontario, Regional Base Hospitals and Referring Hospitals establish local and regional guidelines and rapid transfer protocols to facilitate the timely transfer of STEMI patients directly to a PCI capable site, even when this involves bypassing a closer hospital that does not offer primary PCI.

The protocols should address the full range of possible transportation options including the transport of patients:

- Directly to a cath lab (with no contact).
- Directly to a cath lab after consultation with an interventionalist.
- Directly to a cath lab after consultation with an ED physician.
- To the ED first, and then to a cath lab.

For patients who cannot be transferred to a cath lab, chest pain protocols should instruct EMS providers to advise the ED that a STEMI patient is arriving so that the ED can prepare for fibrinolysis.

If treatment protocols for STEMI patients in transit are included in the bypass protocols, the protocols should accommodate a variety of clinical situations (e.g., the patient arrests prior to or after the cath lab accepting the transfer). The protocols should also cover post-arrest bypass protocols for unstable



patients who are, for example, hypotensive, intubated, paced or cooled. An ECG override protocol should also be included.

The protocols should vary depending on the skill level of the attending paramedic for the ability to bypass and the distance that must be travelled to the primary PCI Centre. Note that PCPs could independently accompany a patient in a bypass for uncomplicated cases.

The implementation of bypass directives can have a significant impact on local EMS resources. For example, as a result of following a bypass protocol, an ambulance may be outside of its assigned area for a relatively long time or even outside of its municipality, depending on the location of the closest PCI Centre. If the bypass protocols are activated regularly, local EMS resources may become depleted. The bypass protocols will need to involve close collaboration with 911 dispatch to ensure the municipality continues to have sufficient EMS coverage during a bypass.

Transfer Times

The Working Group found that it is important to establish a maximum transport time, which could be different for each region, reflecting the unique circumstances of each. There was general consensus that a maximum drive time of 45 minutes would be appropriate, with some discretion to reflect local circumstances and the patient's condition, in which case the maximum transport time should be established with consideration of staying within the E2B time of 90 minutes.

As part of an ongoing quality monitoring program, drive times and the rate of complications should be monitored to determine whether there is a relationship between these variables.

Recommendation 10: That all Emergency Medical Services, in collaboration with the Cardiac Care Network of Ontario and Regional Base Hospitals, establish guidelines for the identification, notification and bypass to PCI Centres for transporting patients suspected of or diagnosed as having STEMI where applicable within established regions according to defined inclusion and exclusion criteria.

The maximum drive time for each LHIN should reflect the local geography, with consideration of the time spent on scene and the ability to achieve the E2B time of 90 minutes. An analysis of drive times to the closest PCI Centre in each of the 14 LHINs is provided in Appendix G.

1.13.3 Inter-hospital Transfers

Best Practice in Inter-hospital Transfers

As indicated throughout this document, timely reperfusion is essential to reduce mortality; however, the mortality benefit achieved with primary PCI in STEMI patients is diminished by treatment delays. It is, therefore, imperative to develop strategies that both increase access to primary PCI and improve D2B times (Miedema, 2011). Inter-hospital transfer delays were identified as one of the most frequent reperfusion delays.

The transfer of patients in a highly automated and coordinated manner to expedite care can be accomplished by a Code STEMI through dispatch where an ambulance is activated as a priority to the ED and the crew responds prior to the activation of the receiving hospital, so that there is no delay

accepting the patient and minimal channels of communications that may break down or cause delays (Miedema, 2011; Le May, 2008).

Helicopter transport for inter-hospital transfers seems unlikely to overcome ground transportation as air medical dispatch, patient “packaging”, and two separate take-offs and landings are likely to consume at least 30 to 35 minutes (Jolis, 2010).

Hospital processes to expedite STEMI patients from triage time to cath lab activation time, cath lab team activation to patient arrival time to cath lab and cath lab arrival to reperfusion are key covariates of rapid reperfusion for EMS STEMI patients (Clark, 2012.)

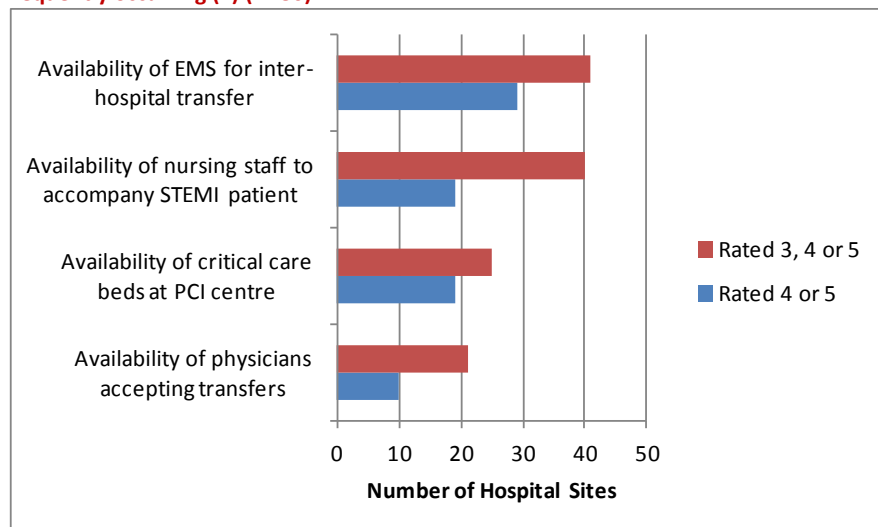
At referring hospitals, focusing on a “door-in door-out” (DIDO) protocol of less than 30 minutes has been shown to improve mortality (Miedema, 2011; Wang, 2011) and is now the recommended benchmark (O’Connor, 2010).

Current Practice in Inter-hospital Transfers

None of the responding services currently have or operate a dedicated ambulance assigned to inter-facility STEMI transfer. The median response time for inter-facility transfer of STEMI patients (call placed to arrival of crew at the transferring hospital) was between four and 15 minutes.

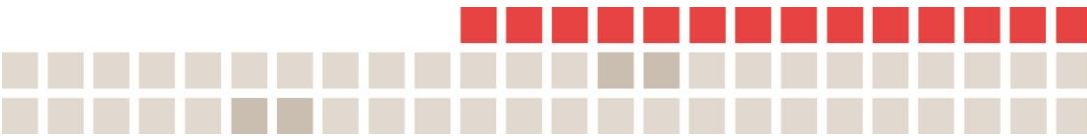
Most transfers from a Referring Hospital to a PCI centre (80.5%) are by EMS. Inter-hospital transfers were reported to require EMS transport with an ACLS certified registered nurse (65.5%) or EMS paramedic (14.9%). The greatest barriers reported to transferring STEMI patients to a PCI Centre were the availability of EMS for the transfer (41 of 86 reported it as 3, 4 or 5, where 5 is the most frequent barrier) and the availability of nursing staff to accompany the patient (40 of 86), as shown in Figure 20.

Figure 20: Barriers when transferring STEMI patients emergently to a PCI hospital with most frequently occurring (5) to least frequently occurring (1) (N=86)



Source: Question 19. Non-PCI Hospital Survey, June 2012

Fourteen of the 16 PCI Centres reported that they accept intubated STEMI patients after active resuscitation for emergent PCI. Most often (12 of 14 PCI Centres), the patient is accepted directly to the



cath lab. The other two hospitals reported that the patients are accepted to the ED to be stabilized, and then transferred to the cath lab.

Gap Analysis

Timely inter-hospital transfer is a critical step in transporting STEMI patients to the cath lab for a primary PCI. EMS, Referring Hospitals and PCI Centres are not currently organized to consistently expedite these emergent transfers.

Recommendations for Inter-Hospital Transfer

Geography and limited resources can potentially hinder access to optimal care for STEMI patients. A coordinated system between EMS, Referring Hospitals and PCI Centres would ensure that patients receive the right therapy at the right time and ultimately improve care for STEMI patients in Ontario.

Once a patient is deemed eligible for primary PCI after presenting to a Referring Hospital, prompt transfer to the appropriate PCI Centre should occur. Given the complexities of the EMS at the municipal level, written agreements are necessary to facilitate timely transfer of patients from a Referring Hospital to a PCI Centre as appropriate.

Recommendation 11: That all Emergency Medical Services establish direct transfer agreements with all area hospitals for the inter-hospital transfer of STEMI patients. These agreements should recognize the emergent nature of these transfers.

One key challenge to moving forward with this recommendation includes the geographical limitations that result in delays in reaching the nearest PCI Centre when a patient presents at a Referring Hospital ED. The solution lies in a coordinated effort between PCI Centres, EMS services and Referring Hospitals.

In addition to the transfer agreements, Referring Hospitals and PCI Centres should establish inter-hospital agreements for the initial acceptance of the STEMI patients and for the repatriation of these patients after treatment. (See recommendation 4.)

These agreements should be supported with standardized protocols that include:

- Timely assessment and diagnosis of STEMI at the Referring Hospital, with a common standard across all hospitals.
- Clinical requirements for transfer eligibility (e.g., diagnosis, patient stability).
- Rapid communication and activation between the Referring Hospital and the PCI Centre.
- An automatic acceptance process (i.e., 'no refusal') for patients who have not been treated with fibrinolysis.
- A system of accelerated referrals and rapid communication channels to expedite patient transfer to the PCI Centre.
- Agreement to transfer patients in a highly automated and coordinated manner to expedite care.
- Repatriation of patients to the Referring Hospital, once the patient is stabilized post-procedure.
- Feedback mechanisms for process improvement and quality control.

Recommendation 12: That the Cardiac Care Network of Ontario develop standardized protocols for the treatment of patients (e.g., antiplatelet and post-lytic management) suspected of or diagnosed as having a STEMI while awaiting transport to a PCI Centre.

1.13.4 Cath Lab Protocols

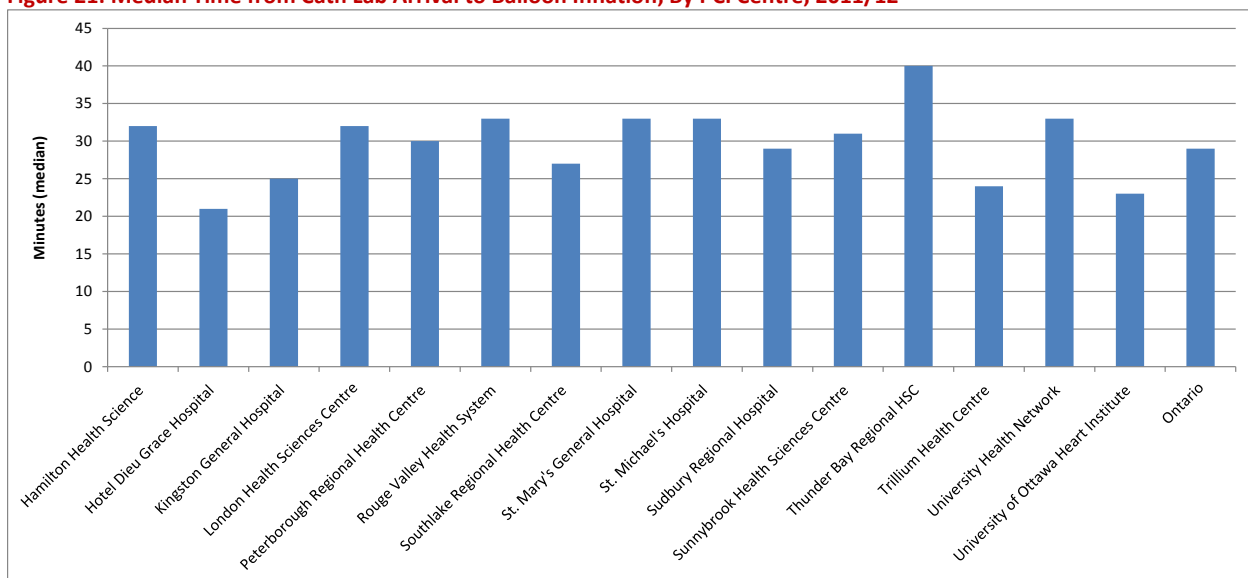
Best Practice

To ensure that those patients who could be treated within these recommended timelines do receive the most appropriate treatment, PCI Centres should establish multidisciplinary teams (including emergency medicine physicians, interventional cardiologists and nurses) to develop guideline-based, institution-specific, written protocols for triaging and managing STEMI patients upon arrival in the cath lab (AHA 2009, Class 1 LEB). This would include streamlining the process for rapid patient assessment, preparation of equipment (e.g., monitor, defibrillator, intra-aortic balloon pump), prepping and draping the patient, performing arterial access, and, finally, performing the diagnostic and interventional procedure.

Current Practice

Leading practices for primary PCI STEMI care are based on the ACC/AHA guidelines that recommend the interval between cath lab arrival time and intracoronary balloon inflation to be 30 minutes or less. That performance metric allows 60 minutes for ED assessment, cath lab activation and transfer time. Since April 2006, CCN has collected primary PCI data to evaluate door-to-balloon times for hospitals in Ontario providing primary PCI. In Ontario, performance against indicators such as cath lab arrival to balloon inflation are consistent with best practice. As shown in Figure 21, the median time in 2011/12 was 29 minutes, ranging from 21 to 40 minutes across the 15 PCI Centres.

Figure 21: Median Time from Cath Lab Arrival to Balloon Inflation, By PCI Centre, 2011/12





Gap Analysis

Current practice in Ontario is consistent with best practices. Therefore, efforts should be made in public education, early diagnosis and bypass protocols by EMS and reduction in inter-facility transfer time to streamline STEMI care, reduce reperfusion time and, ultimately, improve patient outcomes.

Recommendations for Cath Lab Protocols

PCI Centres should continue to monitor arrival to cath lab to balloon inflation times to ensure that they are within the recommended guidelines.

1.14 Real-time Access to Patient Data

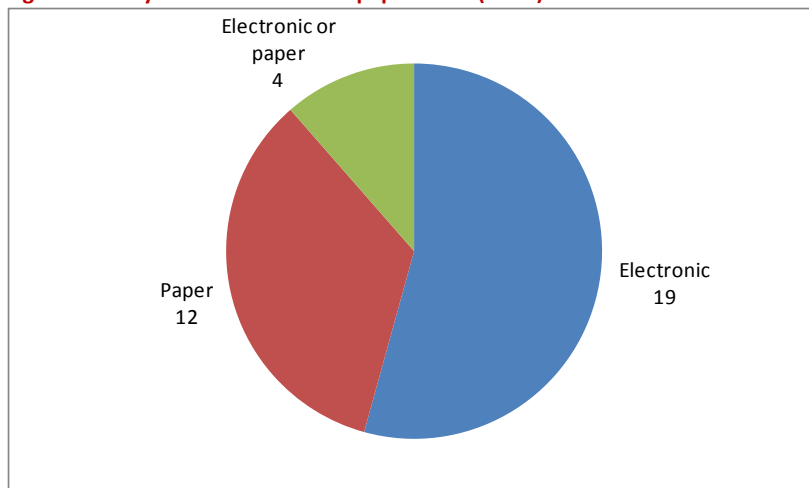
1.14.1 Best Practice

Working Group members were in agreement that it is essential for the physician who looks after a STEMI patient to know what treatments the patient received in the ambulance or at the Referring Hospital before arrival at the PCI Centre.

1.14.2 Current Practice

Nineteen EMS (54%) reported that they use electronic ambulance call reports (ACRs), four reported they use electronic or paper, and 12 continue to use paper (although one was in transition to electronic records). (See Figure 22.)

Figure 22: Do you use electronic or paper ACR? (N=35)




Source: Question 7. EMS Survey, June 2012

For inter-hospital transfers, the patient's chart is often copied and sent with the patient to the PCI Centre.

1.14.3 Gap Analysis

With patients touching up to four different health service providers in 24 hours, and given that times-to-treatment are measured in minutes, treating physicians need real-time data to ensure timely diagnosis and treatment and no duplication of services (e.g., unnecessarily repeated tests, medications administered more than once). Inability to access medical records may cause delays in treatment, increase costs in the system, and, potentially, result in inappropriate treatment and harm.



Treating physicians in EDs and in the cath lab do not always have timely (i.e., immediate) and complete information regarding what diagnostic and therapeutic services have been provided in transit. Even when this information is provided, each EMS has a different format for reporting the information, which may cause a delay in retrieving needed information. Patient data provided by EMS to the ED physician is not currently provided to the PCI Centre, as the PCI Centre is not considered part of the patient's circle of care.

1.14.4 Recommendations for Access to Data

Treating physicians in EDs and in the cath lab must have timely (i.e., immediate) and complete information for STEMI patients. This patient information needs to be documented and shared with the accepting physician immediately on arrival at the ED or the cath lab. This exchange can be on paper or electronic, as long as the transfer of information is immediate and includes standard information. Suggestions for the standard patient information are provided in Appendix H.

Data for STEMI patients must be shared across the entire continuum of care, which means that EMS, Referring Hospitals and PCI Centres must all have access to timely (i.e., immediate) patient data for these patients.

Priority Recommendation 13: That health service providers, including Emergency Medical Services, with the support of their Local Health Integration Network, enable the real-time exchange of data for STEMI patients between Emergency Medical Services, other medical facilities and clinics, Referring Hospitals and PCI Centres, including the provision of 12-lead ECG on arrival at the accepting PCI Centre.



Quality of Care

The Working Group identified two areas of focus related to the quality of care for STEMI patients:

1. The need for regional STEMI networks to ensure rapid access for all STEMI patients to the most appropriate treatment.
2. The need for a provincial quality assurance (QA) program.

1.15 Regional STEMI Networks

The Cardiac Care Network of Ontario's 2009 update (CCN, 2010) noted that a system-wide approach to improving D2B times is necessary to standardize the many processes involved.

1.15.1 Best Practice

Given the requirements for a successful STEMI protocol, regionalization has been shown to be effective in emergency trauma and stroke (Le May, 2008; Ting, 2007; Mackenzie, 2006).

In addition to expanding the pool of eligible patients for reperfusion therapy, regional networks can reduce transport time from first contact, guide transport to the most appropriate hospital, activate the cath lab at the time of prehospital diagnosis, and reduce interhospital transfer delays as well as door-to-balloon times at primary PCI centres. A well-organized network can generally provide primary PCI for most patients within the recommended time constraints, which in turn should lead to better patient outcomes (Huber, 2013; Danchin 2009).

The benefits of these regional networks are generally accepted to be more timely access to life-saving diagnostic and therapeutic interventions. Patient stories from the Central, Central East, Mississauga Halton and Toronto Central LHINs point to the contribution of regional STEMI networks (which include diagnosis of STEMI in the field, bypass protocols, direct activation of the cath lab team and 24/7 access to primary PCI) to saving patient lives. (See Appendix G for the patient stories in the LHIN summaries. Note, however, that some STEMI networks may involve more than one LHIN.)

1.15.2 Current Practice


Several PCI Centres have established regional STEMI networks to ensure appropriate and timely access to diagnosis and treatment, although these protocols vary considerably across the province. (For example, EMS maximum drive times vary from under 30 minutes to under 90 minutes, and cath lab activation can be either prescriptive or discretionary.)

1.15.3 Gaps

Not all PCI Centres in Ontario have a formal regional STEMI network.

1.15.4 Recommendations for Regional Networks

All PCI Centres should ensure that all EMS and Referring Hospitals that are involved in the diagnosis, transport and treatment of STEMI patients in their catchment area participate in a formal regional STEMI network.



Recommendation 14: That all PCI Centres, in collaboration with their Local Health Integration Network, Emergency Medical Services, Regional Base Hospitals and Referring Hospital partners, develop a regional STEMI network to ensure rapid access to appropriate care for all patients diagnosed as or suspected of having a STEMI. All hospitals that treat STEMI patients should be part of a regional STEMI network, in partnership with a PCI Centre (hub-and-spoke model).

A regional STEMI network should operate 24/7 with a “no refusal” policy. The participating PCI Centre should have established relationships with all non-PCI Centres and EMS in its regions. The STEMI patients should flow within the system to allow PCI centre optimal ability to operate and accept all patients. As part of the regional network, representatives from EMS providers, Referring Hospitals and PCI Centres should meet regularly to examine their performance, collect common data (province wide) and report to the provincial oversight committee (e.g., CCN's STEMI Working Group).

1.16 Provincial Quality Assurance Program

In June 2010, Ontario's new *Excellent Care For All Act* (the Act) became law. This Act sets out new standards for the health care system to ensure that:

- The patient is at the centre of the health care system.
- Decisions about patient care are based on the best evidence and standards.
- The health care system is focused on the quality of care and the best use of resources.
- The main goal of the health care system is to get better and better at what it does.¹³

The Act has had a significant impact on hospital boards of directors and management accountability by requiring the health care system to be more responsive to patients, support its decisions by evidence and quality, and be funded in a way that promotes and supports quality and value for money. One specific requirement of the Act is that every hospital has to establish a dedicated Quality Committee to support evidence-based best practices, guidelines and protocols for patient care.

1.16.1 Best Practice

Benefits of a Quality Assurance Program

The goal of a quality assurance program is to reduce the gap between the care that is delivered and the care that ought to be provided (Krumholz et al, 2008). Optimal quality is achievable for STEMI patients where evidence and guidelines exist for implementing effective, timely, safe, equitable, efficient and patient-centred care. There are numerous examples of regional, state-wide and even national STEMI networks that have been successfully implemented over the last two decades using many of the fundamental principles of quality improvement (Goldstein et al, 2013). However, quality assurance cannot occur in isolation but requires the interactions of administrators, health care providers and policymakers within a complex healthcare system. This process needs to be dynamic as clinical evidence, practice patterns, and technologies change, and goals need to be adapted and tailored to the local needs (Chen et al, 2008). In addition, monitoring strategies should be inclusive rather than

¹³ <http://www.health.gov.on.ca/en/ms/ecfa/public/default.aspx> Accessed October 13, 2011



exclusive and report not only performance measures on treated patients but also other system measures such as the number “eligible-untreated” and overall patient outcomes (Campbell et al, 2009).

Relationship Between Procedure Volumes and Patient Outcomes

Registry data show that high volume centres (centres performing more than 36 primary PCI procedures per year) achieve better D2B and are more likely to follow evidence-based guidelines at discharge than lower volume centres with no mortality differences demonstrated (Kumbhani, 2009). The United States has established minimum annual volumes for primary PCI interventionalists (Srinivas, 2009).

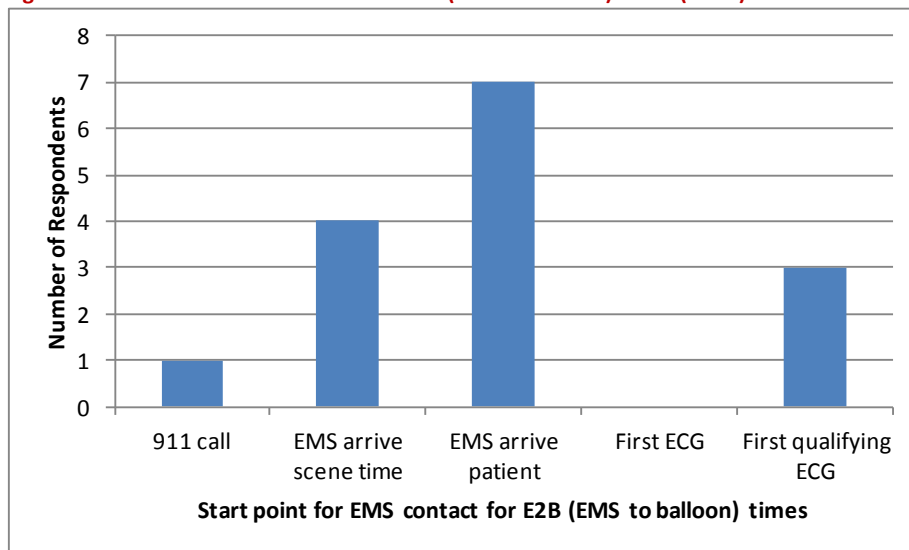
Recommendations for the minimum number of primary PCI procedures per year per centre are 35 (AHA) and 50 (CCN).

1.16.2 Current Practice

Quality Assurance Programs

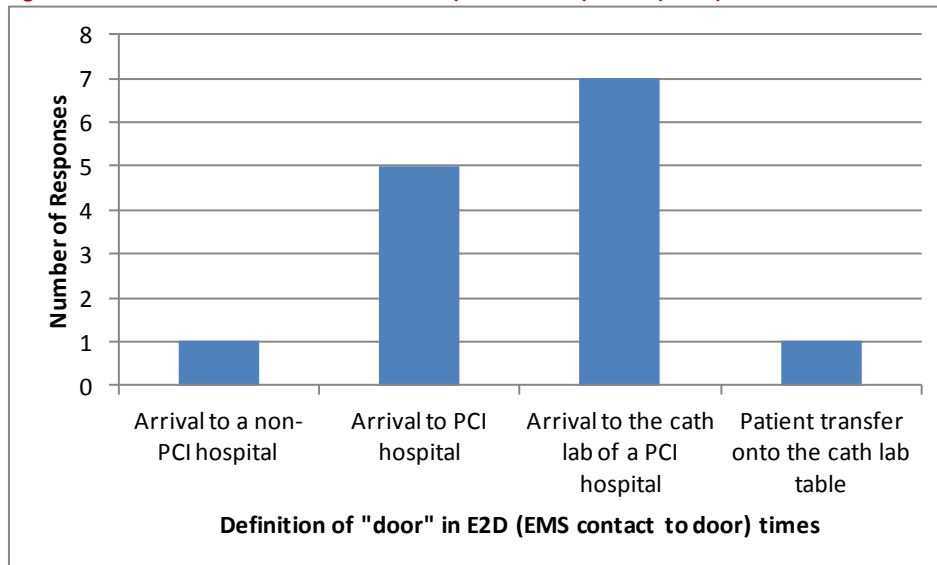
Only 11 (of 33) EMS reported having a dedicated quality assurance process to monitor performance of the STEMI bypass system. EMS that have STEMI quality assurance programs use inconsistent definitions that prevent provincial benchmarking. Of the 15 EMS that monitor time from EMS contact to the insertion of the balloon for PCI (E2B), the definition of EMS contact ranged from the 911 call to the first qualifying ECG, as shown in Figure 23. Similarly, when EMS measure the time from EMS contact to the door of the cath lab (E2D), the definition of “door” is most frequently defined as either the PCI Centre or the cath lab, as shown in Figure 24.

Figure 23: Definition of EMS contact for E2B (EMS to balloon) times (N=15)



Source: Question 31. EMS Survey, June 2012

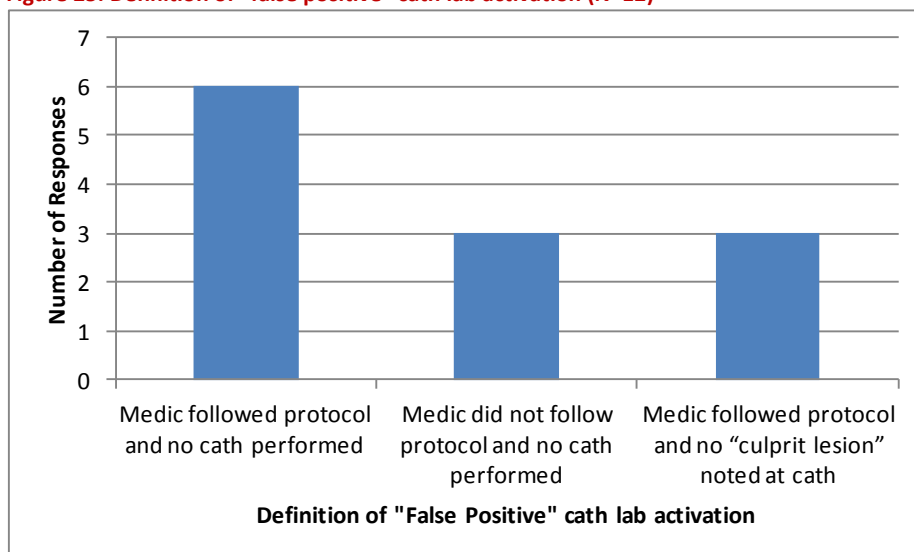
Figure 24: Definition of door contact for E2D (EMS to door) times (N=14)



Source: Question 32. EMS Survey, June 2012

Fifteen (out of 24 responding EMS) reported that they monitor the frequency of “false positive” cath lab activation. The definition of “false positive” is not consistent across the various services, as shown in Figure 25.

Figure 25: Definition of “false positive” cath lab activation (N=12)



Source: Question 33. EMS Survey, June 2012

A recent innovation project undertaken by Hamilton Health Sciences highlights many examples of measurement issues related to monitoring a STEMI network. An excerpt from the final report from this project is provided as Appendix I.

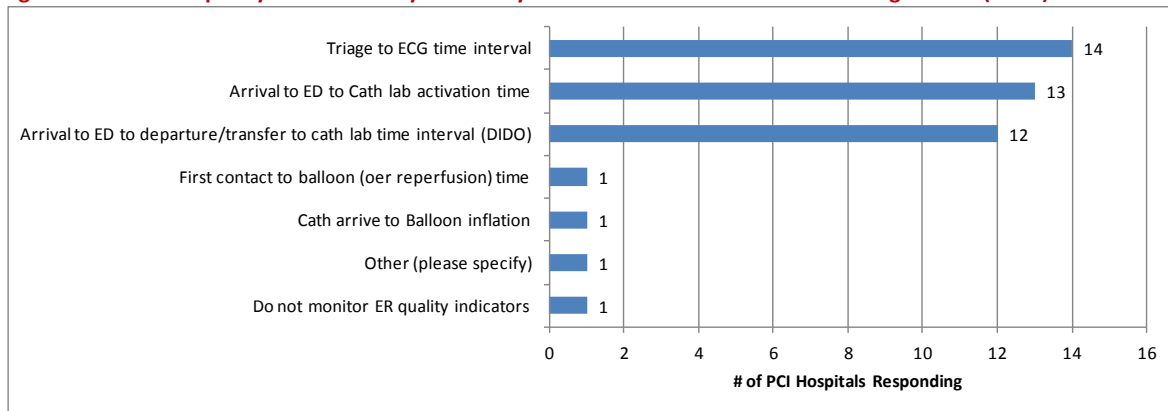


1.17 Quality Monitoring

The most frequently monitored quality indicators for the ED of PCI Centres are shown in Figure 26 and include:

- Triage to ECG time interval (14 of 15 PCI Centres).
- Arrival to the ED to cath lab activation time (13 of 15).
- Arrival to the ED/transfer to cath lab time interval (DIDO) (12 of 15).
- One PCI Centre indicated it does not measure ED quality indicators¹⁴.

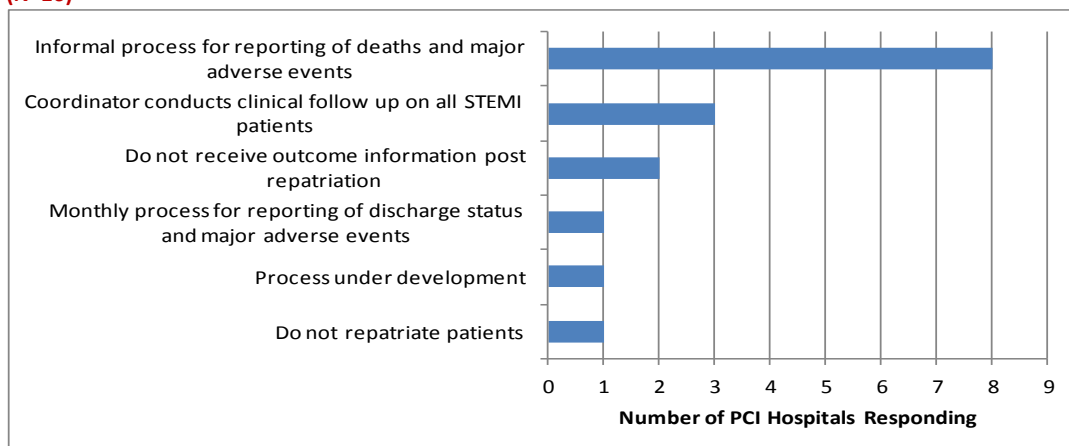
Figure 26: What ED quality indicators do you actively monitor as it relates to STEMI management? (N=15)



Source: Question 6. PCI Hospital Survey, March 2012

Thirteen of 15 PCI Centres reported that they track outcomes for admitted patients. The most frequently used process for tracking post-procedural outcome information for repatriated patients was the informal reporting of major adverse events and deaths, as shown in Figure 27.

Figure 27: How do you track post procedural outcome information for STEMI patients repatriated back to a Non-PCI hospital? (N=16)

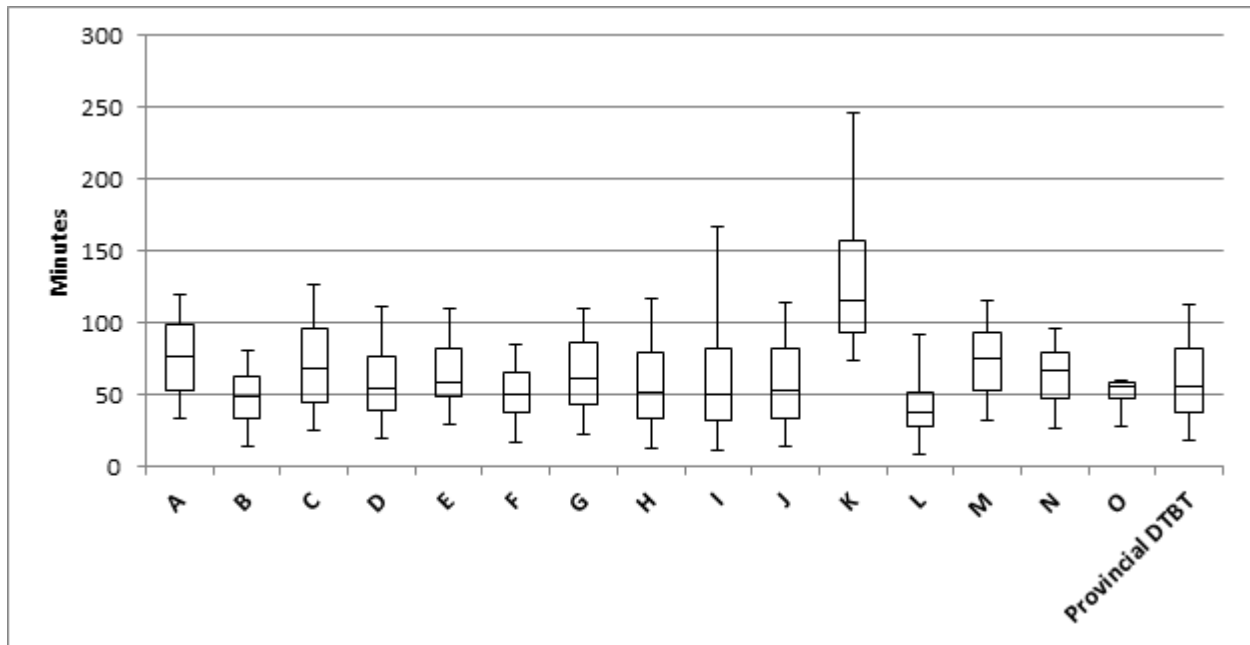


Source: Question 27. PCI Hospital Survey, March 2012

¹⁴ This hospital reported that audits have been done but are no longer routine now that the protocol has been in place for many years.

At a provincial level, CCN currently reports on some of the performance indicators for the province. An example of such a report (door-to-balloon times) is shown in Figure 28.

Figure 28: Sample Provincial Quality Indicator Report, Door-to-Balloon Times, 2011/12



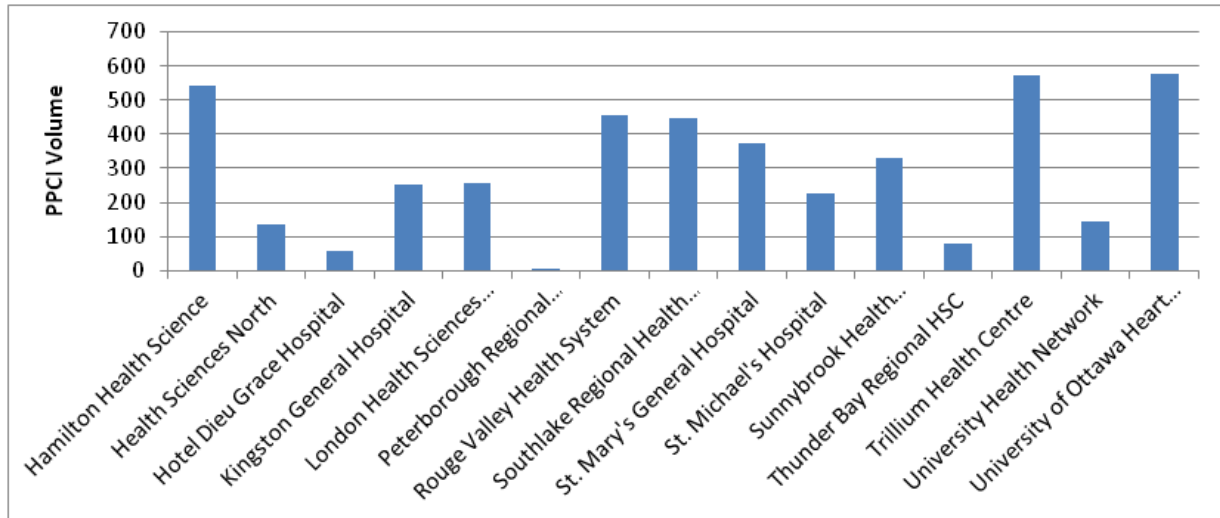
	A	B	C	D	E	F	G	H	I	J	K	L	M	N	O	Provincial DTBT
Min	29	22	13	19	28	11	22	12	13	15	72	11	22	23	32	11
25thP	54	34	45	40	49	37	43	33	32	34	94	28	53	47	48	38
Median	77	49	69	55	59	50	61	52	50	53	116	38	75	67	56	56
75thP	99	64	96	77	82	65	87	79	82	82	157	52	93	80	60	82
90thP	120	81	126	111	110	85	110	117	167	114	246	92	116	96	60	113
<= 90 min	75%	94%	74%	87%	83%	92%	86%	85%	71%	87%	22%	95%	74%	85%	100%	85%
Case Count	137	33	43	93	143	202	104	55	34	114	23	303	58	72	3	1417



Procedure Volumes

The number of urgent PCIs performed by centre per year varies considerable across the province. Only one centre, which only began performing primary PCIs recently, performed fewer than 50 procedures in 2011/12, but is expected to achieve the minimum as its program reaches target volumes. (See Figure 29)

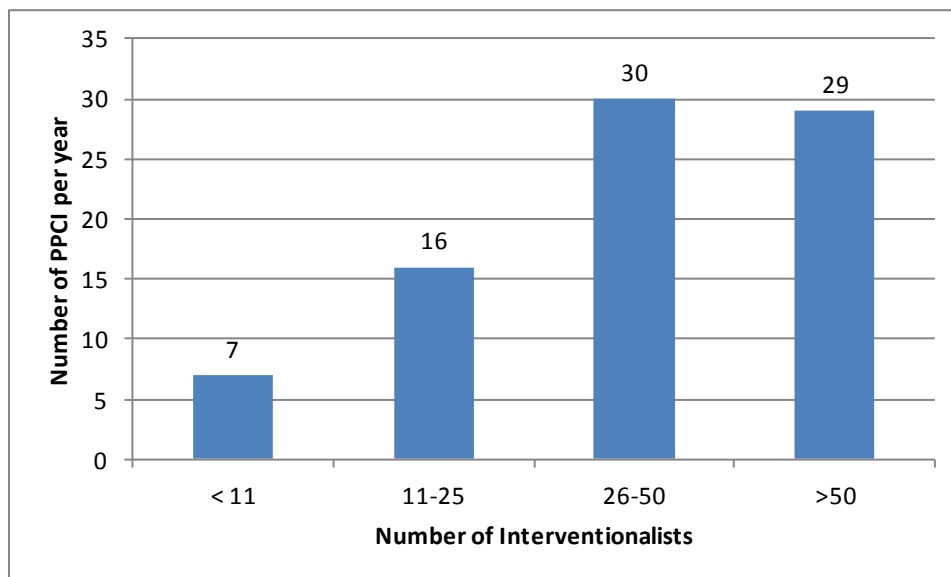
Figure 29: Number of Primary PCIs performed by Centre, 2011/12



Source: CCN Primary PCI Registry

Most interventionalists (59 out of 82) performed more than 26 primary PCI procedures in 2011/12, as shown in Figure 30.

Figure 30: Number of Primary PCI procedures by Interventionalist, Ontario, 2011/12



Source: CCN PPCI Registry



1.17.1 Gaps

There is great variability in the information that different health care providers are collecting, monitoring and using for ongoing feedback and evaluation of STEMI care. Even within the hospital sector, there are differences in data definitions. These providers need to be collecting information with a common goal of improving patient outcomes by improving the processes of care. Sharing of data between providers will allow for a harmonized approach to patient care throughout the journey in the healthcare system.

Not all EMS, Referring Hospitals and PCI Centres have formal quality assurance programs specifically for the care of STEMI patients. Those that do have such programs do not monitor the same indicators or, if they do, the definitions used for the indicators may vary. Accordingly, it is not possible to develop a provincial snap shot of the current delivery of STEMI care or to compare performance across jurisdictions or over time.

The Working Group has no concerns at this time about procedure volumes for maintenance of competence at the institutional or operator level. However, it would be prudent to monitor the number of primary PCI by operator and by centre per year to ensure minimum volumes to maintain competence continue to be met.

1.17.2 Recommendations for Quality Monitoring

There is a need for a provincial quality assurance program to:

- Facilitate transparency and benchmarking of different models for STEMI programs.
- Support new STEMI networks.
- Create standardized definitions for performance indicators.
- Monitor performance and provide recommendations including, but not limited to, procedural success, patient outcomes and major adverse cardiovascular events.
- Promote coordinated care between EMS, Referring Hospitals and PCI Centres.

Recommendation 15: That the Cardiac Care Network of Ontario, with the support of the Ministry of Health and Long-Term Care, develop a provincial quality assurance program for the care of all STEMI patients. The program should define the indicators to be monitored and the data definitions for those indicators. The data definitions and quality indicators used for this program should be consistent with the pan-Canadian data definitions and quality indicators recently developed by the Canadian Cardiovascular Society and the Cardiac Care Network of Ontario.

Recommendation 16: That the Cardiac Care Network of Ontario, with the support of the Ministry of Health and Long-Term Care, add the data needed for the quality assurance program to its provincial cardiac database and develop protocols for the collection, monitoring and reporting of all STEMI cases across the Province.



Performance Measurement

To evaluate the performance of regional STEMI networks, the Working Group proposes that a number of system, process and outcome measures be reported and monitored on a regular basis. These measures should be reported by hospital, by LHIN and for the province overall.

1.18 System Measures

1.18.1 Recommended System Measures

Achieving timely and appropriate treatment for STEMI patients requires the coordinated efforts of health service providers across the full continuum of care. The proposed system measures are intended to measure how well the patient flows through the system and, ultimately, the timeliness of reperfusion.

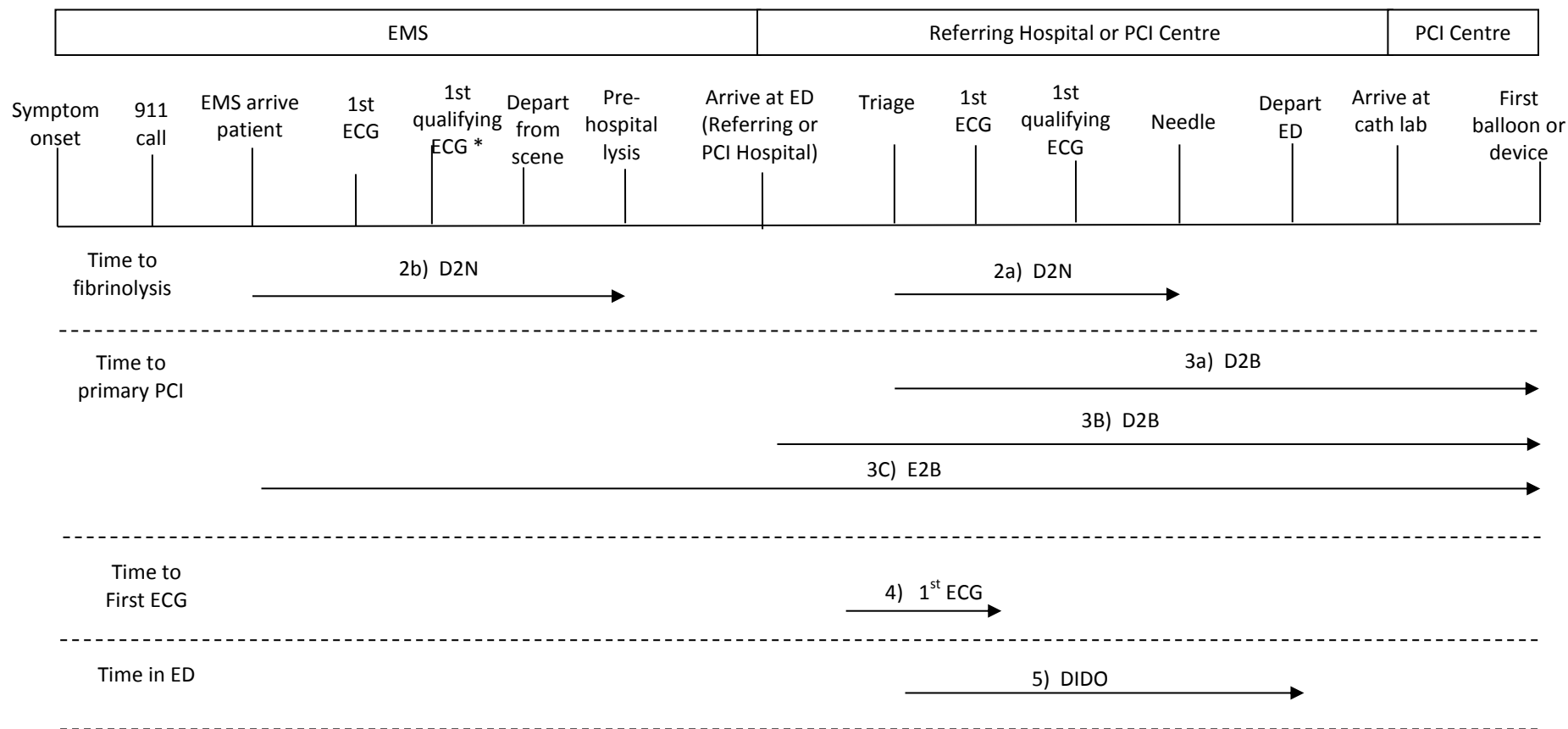
The recommended system measures are shown in Table 4. It is recommended that all measures of elapsed time be reported as the median time, the inter-quartile range (IQR) and the proportion of STEMI patients for whom these benchmarks were met. The table also shows the recommended target for each of the performance indicators, based on best practice as documented in the literature or on the consensus opinion of the Working Group members.

Table 4: Recommended System Measures

#	Dimension	Indicator	Recommended Target
1	Appropriate	<ul style="list-style-type: none"> Proportion of true STEMI patients receiving reperfusion with either primary PCI or fibrinolysis Ratio of STEMI patients receiving primary PCI versus fibrinolysis Proportion of fibrinolysis STEMI patients who are cathed within 24 hours of fibrinolysis Proportion of inappropriate cath lab activations 	
2	Timely	Time to fibrinolysis therapy: <ul style="list-style-type: none"> Door-to-needle time (D2N) 	a) For in-hospital lysis: <ul style="list-style-type: none"> ED arrival to administration of lytic: 30 minutes b) For pre-hospital lysis: <ul style="list-style-type: none"> Scene arrival to administration of lytic 30 minutes
3	Timely	Time to primary PCI <ul style="list-style-type: none"> Door-to-balloon time (D2B) EMS arrival at patient to balloon time (E2B) 	a) For walk-in patients arriving at PCI Centre: <ul style="list-style-type: none"> 90 minutes b) For patients arriving at Referring Hospital: <ul style="list-style-type: none"> 120 minutes c) For EMS with field ECG to cath lab: <ul style="list-style-type: none"> 90 minutes (target)
4	Timely	Time to first ECG	<ul style="list-style-type: none"> 10 minutes
5	Timely	Time from arrival at ED to departure from ED (DIDO)	<ul style="list-style-type: none"> ED arrival to EMS transfer : 30 minutes

The time intervals and proposed system measures are shown graphically in Figure 31.

Figure 31: Recommended System Performance Indicators for Timeliness



* First qualifying ECG could happen while the patient is in the ambulance.

D2N: Door to needle

D2B: Door to balloon

See the Glossary for a definition of the indicators.

E2B: First medical contact (EMS) to insertion of reperfusion device

DIDO: Door in door out



1.18.2 Data Requirements for System Measures

The reporting of system indicators will require timely and accurate data from EMS and from hospitals. Much of the needed data are already collected; however, some additional data elements will be required.

The specific data elements needed to calculate the timeliness measures shown in Table 4 are detailed in Table 5.

Table 5: Data Requirements for System Measures (Time stamps only)


#	Indicator	Data requirements		
		From EMS	From Referring Hospitals	From PCI Centres
2a	D2N (in-hospital)		Arrive at ED Administration of lytic	Arrival at ED or cath lab Administration of lytic
2b	D2N (pre-hospital)	Arrival at scene Administration of lytic		
3a	D2B			Arrival at ED First balloon (device)
3b	D2B (referral)		Arrival at ED	First balloon (device)
3c	E2B	Arrival at scene or patient		First balloon (device)
4	First ECG	Arrival at scene 1st ECG	Arrival at ED 1 st ECG	Arrival at ED 1 st ECG
5	DIDO		Arrival at ED Depart ED	
	Not specific to any indicator 911- balloon time (measure of system performance)	911 call Qualifying ECG Depart from scene 911 call	Qualifying ECG	First balloon (device)

1.19 Process Measures

Several utilization measures will shed light on the care processes used to manage STEMI patients after reperfusion, including the proportion of STEMI patients who are referred for cardiac rehabilitation or a smoking cessation program. These types of measures ensure that high quality patient care is provided along the entire continuum of care.

The in-hospital length of stay (LOS) will also highlight variations from best practice in post-procedural management.

After reperfusion, it is important that the STEMI patient be prescribed appropriate medications to reduce the risk of future blockages (e.g., blood thinners). The Working Group proposes to evaluate the



post-procedural care of STEMI patients by measuring the proportion of STEMI patients who have been reperfused and who are on each of the following medications at discharge from hospital:

- Acetylsalicylic acid (ASA).
- A second antiplatelet agent (P2Y12 antagonist).
- Beta-blocker.
- Statin (lipid-lowering).
- Angiotensin-converting-enzyme (ACE) inhibitor or angiotensin receptor blocker (ARB).

It is also important to refer patients for smoking cessation intervention and cardiac rehabilitation as indicated.

1.20 Outcome Measures

The quality and timeliness of STEMI care is expected to contribute to better outcomes for patients. Accordingly, the effectiveness of this provincial strategy can be evaluated using the following outcome measures:

- 30-day mortality.
- In-hospital mortality.
- 30-day readmission.
- 30-day reinfarction rate.
- In-hospital bleeding or transfusion.
- 30-day stroke or intracranial hemorrhage (ICH).

1.21 Other Reportable Measures

Several other indicators will be of use in understanding the current delivery of STEMI care in Ontario, and recognizing how patterns of care change over time. Specifically, the Working Group is recommending the reporting and monitoring of the following indicators:

- Proportion of STEMI patients arriving at the hospital by EMS or on their own (i.e., "walk ins").
- Proportion of STEMI patients receiving in-hospital cath following fibrinolysis therapy:
 - Pharmacoinvasive/rescue PCI within 6 hours and within 24 hours.
 - Other in-hospital cath within 24 hours.
- Proportion of STEMI patients who are repatriated to the hospital from which they were transferred.
- Inappropriate activation for patients transferred for primary PCI.



Summary and Conclusions

1.22 Appropriateness of Care

The distinction between appropriate and timely care for STEMI patients is somewhat artificial because how quickly the patient can be treated determines the most appropriate treatment:

- If the recommended timelines can be met, the patient should be referred for primary PCI.
- If the recommended timelines for primary PCI cannot be met, the patient should be given fibrinolysis, with a view to an early invasive strategy post fibrinolysis therapy.

Using currently available data, the Working Group estimated that approximately 77% of patients diagnosed with STEMI undergo reperfusion (i.e., primary PCI or fibrinolysis therapy). However, there are currently no comprehensive standardized data regarding the total number of STEMIs in Ontario, which creates difficulties in estimating the incidence of STEMI and, therefore, reperfusion rates. Without these data, it is difficult to assess with confidence whether this patient population has access to appropriate and timely care.

Although a large proportion of Ontario's population lives within 60 minutes drive time of a PCI Centre, some communities in Northern Ontario have limited access to reperfusion (i.e., fibrinolysis therapy).

Most Referring Hospitals (94%) have a STEMI protocol in place; however, reperfusion strategies vary significantly across hospitals. Although all PCI Centres have (or are developing) a primary PCI program, strategies for reperfusion also vary across centres. The lack of repatriation agreements with Referring Hospitals was cited by some PCI centres as a barrier to providing primary PCI on a 24/7 basis.

1.23 Timeliness of Care


Timely access to reperfusion (either primary PCI or fibrinolysis therapy) depends on the timely diagnosis, transport and treatment of STEMI patients.

Paramedics with appropriate training can successfully interpret 12-lead ECGs to identify STEMI patients in the field. However, this equipment is not mandatory for EMS in Ontario. Two EMS services in the Northeast and Northwest reported that they did not have vehicles equipped with 12-lead ECGs. Among EMS that have protocols in place for the identification of STEMI patients, there is a great deal of variation in the protocols.

Only 77% of Referring Hospital Emergency Departments (EDs) reported having STEMI protocols.

Although delayed cath lab activation has been shown to contribute to major delays in the time to treatment for STEMI patients, not all EMS and EDs have protocols in place to ensure timely activation. Similarly, the literature supports the use of bypass protocols to ensure timely transport of STEMI patients directly to the receiving cath lab, such protocols are not in place in all EMS in Ontario. Where they are in use, the protocols are not standardized across the province.

Most PCI Centres have developed treatment plans for STEMI patients mainly focused on access to primary PCI, although many continue to operate without a formal regional network involving EMS and



Referring Hospitals. Conversely, not all non-PCI hospitals are affiliated explicitly with a regional STEMI network; protocols for STEMI care, where they exist, vary considerably and are not necessarily consistent with best practice for timely diagnosis, transport and treatment of these patients.

Treating physicians in EDs and in the cath lab must have timely (i.e., immediate) and complete information for STEMI patients across the full continuum of care. Currently, receiving physicians (e.g., in the cath lab) do not always receive information on the patient's condition, diagnostic tests conducted and the results of those tests, or medications administered since symptom onset. Without this information, treatment can be delayed (e.g., while waiting for retesting) or duplicated.

A critical step in the timely diagnosis of STEMI patients is for the patient (or family member) to call 911 rather than proceeding on their own to an ED, which adds to the overall time from symptom onset to diagnosis and treatment. In Ontario in 2012, approximately 36% of diagnosed STEMI patients arrived at EDs on their own. A public service campaign is needed to raise awareness of the importance of calling 911 for medical emergencies. Further research is required to understand the reasons why patients do not call 911, and strategies should be developed to overcome these barriers.

1.24 Quality of Care

There is great variability in the information that different health care providers are collecting, monitoring and using for ongoing feedback and evaluation of STEMI care. Even within the hospital sector, there are differences in data definitions. These providers need to be collecting information with a common goal of improving patient outcomes by improving the processes of care. Sharing of data between providers will allow for a harmonized approach to patient care throughout the journey in the healthcare system.

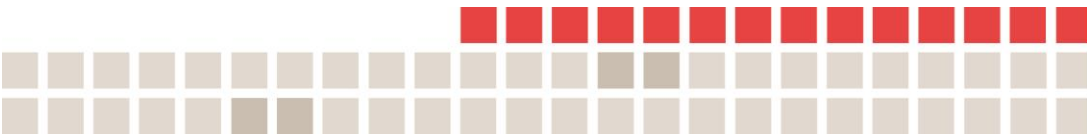
Not all EMS, Referring Hospitals and PCI Centres have formal quality assurance programs specifically for the care of STEMI patients. For example, only 11 (of 33) EMS reported having a dedicated quality assurance process to monitor performance of the STEMI bypass system. Those that do have such programs do not monitor the same indicators or, if they do, the definitions used for the indicators may vary. Accordingly, it is not possible to develop a provincial snap shot of the current delivery of STEMI care or to compare performance across jurisdictions or over time.

1.25 Conclusions

The Working Group has articulated two goals for STEMI care in Ontario, which are consistent with the findings and recommendations of the 2004 Report:

- All eligible STEMI patients are reperfused within the recommended timelines.
- If the timelines can be met, the preferred reperfusion strategy is primary PCI.

The Working Group recognizes that some degree of regionalization of services is needed to ensure each centre has a critical mass of patient volumes to maintain competence and achieve operational efficiencies. However, the regionalized nature of primary PCI services creates a need for strategies, based on the best available evidence, to expedite the diagnosis, transport and treatment of STEMI patients to strive for the treatment of all patients within the recommended times.



Accordingly, the Working Group's recommendations address the need for:

- The development of regional networks involving LHINs (note that one or more LHINs may be involved), emergency medical services, Regional Base Hospitals, Referring Hospitals, EDs and PCI centres to organize the timely diagnosis and treatment of all STEMI patients.
- The development of protocols for timely processes in each step in the patient's journey from diagnosis to transport to treatment.
- Support for the regional networks (e.g., the ability for EMS to diagnose STEMI patients, and for all members of the care team to have immediate access to patient information to inform the treatment).
- A provincial quality assurance program to define, monitor and report on performance metrics.

The Working Group found that, with a relatively focused investment in a number of limited areas, building on existing infrastructure and resources, significant gains could be expected in the appropriateness, timeliness and quality of care for these patients.

Once implemented, the Working Group's recommendations will result in:


- More efficient use of pre-hospital resources, with some patients travelling directly to the PCI Centre instead of stopping first at the local ED.
- Better patient outcomes (e.g., reduced morbidity and mortality), as patients receive the right care (reperused) in the right place (PCI Centre) at the right time (within the recommended timelines).

References

- Antman, E.M., Anbe, D.T., Armstrong, P.W., Bates, E.R., Green, L.A., Hand, M.,... Smith, S.C. Jr. (2004) ACC/AHA guidelines for the management of patients with ST-elevation myocardial infarction: executive summary: a report of the ACC/AHA Task Force on Practice Guidelines (Committee to Revise the 1999 Guidelines on the Management of Patients With Acute Myocardial Infarction). *Journal of the American College of Cardiology*, 44, 671–719.
- Antman, E.M., Anbe, D.T., Armstrong, P.W., Bates, E.R., Green, L. A., Hand, M.,... Ornato, J.P. (2008). ACC/AHA guidelines for the management of patients with ST-elevation myocardial infarction: a report of the American College of Cardiology/ American Heart Association Task Force on Practice Guideline. *Journal of the American College of Cardiology*, 51, 210-47.
- ASSENT-4 PCI investigators. (2006). Primary versus tenecteplase-facilitated percutaneous coronary intervention in patients with ST-segment elevation acute myocardial infarction (ASSENT-4 PCI): randomised trial. *Lancet*, 367(9510), 569-578.
- ATOLL presented at the European Society of Cardiology, 2011.
- Bell, A.D., & Tanguay, J-F. (2011). The use of antiplatelet therapy in the outpatient setting: Canadian Cardiovascular Society Guidelines. *Canadian Journal of Cardiology*, 27, 3S:S6–S16.
- Berger, P.B., Ellis, S.G., Holmes Jr, D.R., Granger, C.B., Criger, D.A., Betriu, A.,...GUSTO-II Investigators. (1999). Relationship between delay in performing direct coronary angioplasty and early clinical outcome in patients with acute myocardial infarction. *Circulation*, 100, 14-20.
- Bradley E.H., Herrin J, Wang Y, Barton B.A, Webster, T.R., Mattera, J.A.,... Krumholtz, H.M. (2006). Strategies for reducing the door-to-balloon time in acute myocardial infarction. *New England Journal of Medicine*, 355(22), 2308-20.
- Campbell, A.R., Satran, D., Larson, D.M, Chavez, I.J., Unger, B.T., Chacko, B.P... Henry, T.D., ST-Elevation Myocardial Infarction: Which Patients Do Quality Assurance Programs Include? *Circ Cardiovasc Qual Outcomes*. 2009;2:648-655.
- Canadian Cardiovascular Society. (2012) Data dictionary: A CCS Consensus Document. Retrieved from <http://ddqi.ccs.ca>
- Cantor, W.J., Fitchett, D., Borgundvaag, B., Ducas, J., Heffernan, M., Cohen, E.A.,...Goodman, S.G. (2009) Routine early angioplasty after fibrinolysis for acute myocardial infarction. *New England Journal of Medicine*, 360, 2705-18.
- Cantor, W.J., Hoogeveen, P., Robert, A., Elliott, K., Goldman, L.E., Sanderson, E.,... Miner, S. (2012). Prehospital diagnosis and triage of ST-elevation myocardial infarction by paramedics without advanced care training. *American Heart Journal*, 164 (2), 201-6.
- Cantor, W.J., Ko, D.T., Natarajan, M., Le May, M.R., Dzavik, V., Velianou, J.L.,... Kingsbury, K. (2011). Reperfusion Times for Radial vs. Femoral Access in Patients with ST-Elevation Myocardial Infarction Undergoing Primary PCI: Observations from the CCN Provincial Primary PCI Registry. Canadian Cardiovascular Society Abstract.
- Cardiac Care Network of Ontario. (2004). Access to Urgent PCI for ST Segment Elevation Myocardial

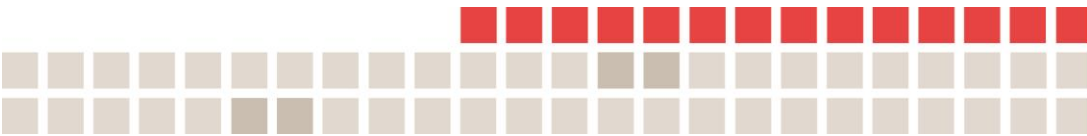


- Infarction. Final Report and Recommendations. Submitted to the Ontario Ministry of Health and Long-Term Care.
- Cardiac Care Network of Ontario. (2010). Primary Percutaneous Coronary Intervention. Optimizing Access to primary PCI for ST Elevation Myocardial Infarction. Final Report.
- Chan, A.W., Bakar, S.N., Brown, R.I., Kuritzky, R., Lalani, A., Gordon, W.,... Simkus, G.J. (2011). In-hospital outcomes of a regional ST-segment elevation myocardial infarction acute transfer and repatriation program. *Canadian Journal of Cardiology*, 27(5), 664 e1-8.
- Chen, J., Normand, S.T., Myocardial infarction and quality of care. *CMAJ* 2008;179(9):909-15).
- Chen, Z.M., Jiang, L.X., Chen, Y.P., Xie, J.X., Pan, H.C., Peto, R.,... Lui, L.S. (2005). Addition of clopidogrel to aspirin in 45,852 patients with acute myocardial infarction: randomised placebo-controlled trial. *Lancet*, 366(9497), 1607–1621.
- Cheskes, S., Turner, L., Foggett, R., Huiskamp, M., Popov, D., Thomson, S.,...Verbeek, R. (2011). Paramedic Contact to Balloon in Less than 90 Minutes: A Successful Strategy for ST-Segment Elevation Myocardial Infarction Bypass to Primary Percutaneous Coronary Intervention in a Canadian Emergency Medical System. *Prehospital Emergency Care*, 15(4), 490-498.
- Clark, C.L., Berman, A.D., McHugh, A., Roe, E.J., Boura, J., & Swor, R.A. (2012). Hospital Process Intervals, not EMS time intervals, are the most important Predictors of Rapid Reperfusion in EMS Patients With ST-segment Elevation Myocardial Infarction. *Prehospital Emergency Care*, 16(1), 115-120.
- Curtis, J.P., Portnay, E.L., Wang, Y., McNamara, R.L., Herrin, J., Bradley, E.H.,... Krumholtz, H.M. (2006). The pre-hospital electrocardiogram and time to reperfusion in patients with acute myocardial infarction, 2000-2012. *Journal of the American College of Cardiology*, 47(8), 1544-52.
- Danchin H. (2009). Systems of care for ST-segment elevation myocardial infarction.: impact of different models on clinical outcomes. *Journal of the American College of Cardiology: Cardiovascular Intervention*, 2 (10) 901-908
- De Luca, G., Suryapranata, H., van Hof, A.W., de Boer, M.J., Hoorntje, J.C., Dambrink, J.H.,...Zijlstra, F. (2004). Prognostic Assessment of Patients With Acute Myocardial Infarction Treated With Primary Angioplasty: Implications for Early Discharge. *Circulation*, 109(22), 2737-2743.
- De Luca, G., Navarese, E., Marino, P. (2009). Risk profile and benefits from Gp IIb-IIIa inhibitors among patients with ST-segment elevation myocardial infarction treated with primary angioplasty: a meta-regression analysis of randomized trials. *European Heart Journal*, 30(22), 2705–2713.
- Fitchett, D.H., Theroux, P., Brophy, J.M., Cantor, W.J., Cox, J.L., Gupta, M.,... Goodman, S.G. (2011). Assessment and Management of Acute Coronary Syndromes (ACS): A Canadian Perspective on Current Guideline-Recommended Treatment – Part 2: ST-Segment Elevation Myocardial Infarction. *Canadian Journal of Cardiology*, 27(6), S402-S412.
- Fitchett, D.H., Theroux, P., Brophy, J.M., Cantor, W.J., Cox, J.L., Gupta, M.,... Goodman, S.G. (2011). Assessment and Management of Acute Coronary Syndromes (ACS): A Canadian Perspective on




Current Guideline-Recommended Treatment – Part 2: ST-Segment Elevation Myocardial Infarction. *Canadian Journal of Cardiology*, 27 (6) Supplement, S402-S412.

- Glazier, R.H., Gozdyra, P., Yeritsyan, N. (2011). *Geographic Access to Primary Care and Hospital Services for Rural and Northern Communities: Report to the Ontario Ministry of Health and Long-Term Care*. Toronto: Institute for Clinical Evaluative Sciences.
- Halkin, A., Singh, M., Nikolsky, E., Grines, C.L., Tchenig, J.E., Garcia, E.,...Stone, G.W. (2005). Prediction of Mortality After Primary Percutaneous Coronary Intervention for Acute Myocardial Infarction: The CADILLAC Risk Score. *Journal of the American College of Cardiology*, 45(9):1397-1405.
- Hannan, E.L., Racz, M., Ryan, T.J., McCallister, B.D., Johnson, L.W., Arani, D.T.,...Topol, E.J. (1997). Coronary angioplasty volume-outcome relationships for hospitals and cardiologists. *JAMA*, 277(11), 892-898.
- Ho V. (2000). Evolution of the Volume-Outcome Relation for Hospitals Performing Coronary Angioplasty. *Circulation*, 101, 1806-1811.
- Huber, K., Goldstein, P., Danchin, N., Fox, K.A., Welsh, R., Granger, C.B.,... Gersh, B.J. (2013). Enhancing the efficacy of delivering reperfusion therapy: A European and North American experience with ST-segment elevation myocardial infarction networks. *American Heart Journal*, 165(2), 123-132.
- Jolis, J.G. (2010). Moving Care Forward. *Circulation*, 122, 1443-1445.
- Kotowycz, M.A., Cosman, T.L., Tartaglia, C., Afzal, R., Syal, R.P., & Natarajan, M.K. (2010). Safety and feasibility of early hospital discharge in ST-segment elevation myocardial infarction – A prospective and randomized trial in low-risk primary percutaneous coronary intervention patients (the Safe-Depart Trial). *American Heart Journal*, 159(1), 117 e1-6.
- Krumholz, H.M., Bradley, E.H., Nallamothu, B.K., Ting, H.H., Batchelor, W.B., Kline-Rogers, E.,... Byrd, J.R. (2008). A campaign to improve the timeliness of primary percutaneous coronary intervention. Door-to-balloon: An alliance for quality. *Journal of the American College of Cardiology Interventions*, 1(1), 97-104.
- Krumholz, H.M., Anderson, J.L., Bachelder, B.L., Fesmire, F.M., Fihn, S.D., Foody, J.M., ... Nallamothu, B.K. ACC/AHA 2008 Performance measures for adults with ST-elevation and non-ST-elevation myocardial infarction. *Circulation*. 2008;118:2596-2648.
- Krumholz Hm et al *Circulation* December 2009
- Kumbhani, D.J., Cannon, C.P., Fonarow, G.C., Liang, L., Askari, A.T., Peacock, W.F.,... Bhatt, D.L. (2009). Association of hospital primary angioplasty volume in ST-segment elevation myocardial infarction with quality and outcomes. *JAMA*: 302(20), 2207-2213.
- Kushner et al. (2009). Focused Updates: STEMI and PCI guidelines. *Journal of the American College of Cardiology*, 54(23), 2205-2241.
- Kushner, F.G., Hand, M., Smith, S.C., King, S.B., Anderson, J.L., Antman, E.M.,...Williams, D.O. (2009). Focused Updates: ACC/AHA Guidelines for the Management of Patients With ST-Elevation Myocardial Infarction (Updating the 2004 Guideline and 2007 focused update) and ACC/AHA/SCAI Guidelines on Percutaneous Coronary Intervention (Updating the 2005 Guideline and 2007 focused update) (A Report of the American College of Cardiology

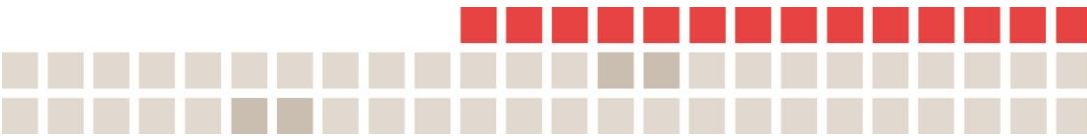


- Foundation/American Heart Association Task Force on Practice Guidelines). *Circulation*, 120, 2271–2306.
- Lambert, L., Brown, K., Segal, E., Brophy, J., Rodes-Cabau, J., & Bogaty, P. (2010). Association between timeliness of reperfusion therapy and clinical outcomes in ST-elevation myocardial infarction. *JAMA*, 303(21), 2148-55.
- Larson, D.M., Menssen, K.M., Sharkey, S.W., Duval, S., Schwartz, R.S., Harris, J.,... Henry, T.D. (2007). "False-positive" cardiac catheterization laboratory activation among patients with suspected ST-segment elevation myocardial infarction. *JAMA*, 298(23), 2754-2760.
- Le May, M.R., Dionne, R., Maloney, J., Trickett, J., Watpool, I., Ruest, M.,... Davies, R.F. (2006). Diagnostic performance and potential clinical impact of advanced care paramedic interpretation of ST-segment elevation myocardial infarction in the field. *Canadian Journal of Emergency Medicine*, 8(6), 401-407.
- Le May, M.R., So, D.Y., Dionne, R., Glover, C.A., Froeschl, M.P.V., Wells, G.A.,...Labinaz, M. (2008). A citywide protocol for primary PCI in ST-segment elevation myocardial infarction. *The New England Journal of Medicine*, 358, 231-240.
- Le May, M.R., Wells, G.A., So, D.Y., Glover, C.A., Froeschl, M., Maloney, J.,... Labinaz, M. (2012). Reducation in Mortality as a Result of Direct Transport from the Field to a Receiving Center for Primary Percutaneous Coronary Intervention. *Journal of the American College of Cardiology*, 60(14), 1223-30.
- Lee, C.H., Van Gelder, C.M., & Cone, D.C. (2010). Early cardiac catheterization laboratory activation by paramedics for patients with ST-segment elevation myocardial infarction on prehospital 12-lead electrocardiograms. *Prehospital Emergency Care*, 14(2), 153-158.
- MacKenzie, E.J., Rivara, F.P., Jurkovich, G.J. Nathens, A.B., Frey, K.P., Egleston, B.L.,... Scharfstein, D.O. (2006). A national evaluation of the effect of trauma-center care on mortality. *The New England Journal of Medicine*, 354, 366-78.
- Maynard, C., Every, N.R., Chapko, M.K., & Ritchie, J.L. (1999). Institutional volumes and coronary angioplasty outcomes before and after the introduction of stenting. *Effective Clinical Practice* 2(3), 108-113.
- McCabe, J.M., Armstrong, E.J., Hoffmayer, K.S., Bhave, P.D., MacGregor, J.S., Hsue, P.,... Ganz, P. (2012). Impact of Door-to-Activation Time on Door-to-Balloon Time in Primary Percutaneous Coronary Intervention for ST-Segment Elevation Myocardial Infarctions: A Report From the Activate-SF Registry. *Circulation: Cardiovascular Quality and Outcomes*, 5(5), 672-679.
- Mercuri, M., Velianou, J.L., Welsford, M., Gauthier, L., & Natarajan, M.K. (2010). Improving the timeliness of care for patients with acute ST-elevation myocardial infarction: implications of "self-transport" versus use of EMS. *Healthcare Quarterly* 13(1) 105-109.
- Miedema, M.D., Newell, M.C., Duval, S., Garberich, R.F., Handran, C.B., Larson, D.M.,... Henry, T.D. (2011). Causes of Delay and Associated Mortality in Patients Transferred With ST-Segment-



Elevation Myocardial Infarction. *Circulation*, 124(15), 1636-1644.

- Montalescot, G., Wiviott, S.D., Braunwald, E., Gibson, C.M., McCabe, C.H., Antman, E.M., & TRITON-TIMI Investigators. (2009). Prasugrel compared with clopidogrel in patients undergoing percutaneous coronary intervention for ST-elevation myocardial infarction (TRITON-TIMI 38): double-blind, randomised controlled trial. *Lancet*, 373(9665), 723–731.
- Nallamothu, B.K., & Bates, E.R. (2003). Percutaneous coronary intervention versus fibrinolytic therapy in acute myocardial infarction: Is timing (almost) everything? *American Journal of Cardiology*, 92(7), 824-826.
- O’Gara, P.T., Kushner, F.G., Ascheim, D.D., Casey Jr, D.E., Chung, M.K., de Lemos, J.A.,... Zhao, D.X. (2013). ACCF/AHA Guideline for the Management of ST-Elevation Myocardial Infarction. A Report of the American College of Cardiology Foundation/American Heart Association Task Force on Practice Guidelines. *Circulation*, 127, e362-e425.
- O’Connor, R. E., Brady, W., Brooks, S.C., Diercks, D., Egan, J., Ghaemmaghami, C.,... Yannapolous, D. (2010). Part 10: Acute Coronary Syndromes: 2010 American Heart Association Guidelines for Cardiopulmonary Resuscitation and Emergency Cardiovascular Care Science. *Circulation: Journal of the American Heart Association*, 122(18), 787-817.
- Randomised trial of intravenous streptokinase, oral aspirin, both, or neither among 17,187 cases of suspected acute myocardial infarction (ISIS-2. ISIS-2 (Second International Study of Infarct Survival) Collaborative Group). (1998). *Lancet*, 2, 349–360.
- Ritchie, J.L., Maynard, C., Chapko, M.K., Every, N.R., & Martin, D.C. (1999). Association between percutaneous transluminal coronary angioplasty volumes and outcomes in the Healthcare Cost and Utilization Project 1993-1994. *American Journal of Cardiology*, 83, 493-497.
- Rokos, I.C., French, W.J., Koenig, W.J., Stratton, S.J., Nighswonger, B., Strunk, B.,...King, S.B 3rd. (2009). Integration of prehospital electrocardiograms and ST-elevation myocardial infarction receiving center (SRC) networks: impact on door-to-balloon times across 10 independent regions. *Journal of the American College of Cardiology: Cardiovascular Intervention*, 2(4), 339-346.
- Rollando, D., Puggioni, E., Robotti, S., De Lisi, A., Ferrari Bravo, M., Vardanega, A., Pattaro, I., DeBenedetti, F., Brignole, M. (2012). Symptom onset-to-balloon time and mortality in the first seven years after STEMI treated with primary percutaneous coronary intervention. *Heart*, 98(23), 1738-42.
- Sabatine, M.S., Cannon, C.P., Gibson, C.M., López-Sendón, J.L., Montalescot, G., Theroux, P.,...Braunwald, E. (2005) Addition of clopidogrel to aspirin and fibrinolytic therapy for myocardial infarction. *The New England Journal of Medicine*, 352, 1179–1189.
- Simoons, M.L., Maggioni, A.P., Knatterud, G., Leimberger, J.D., de Laegere, P., van Domburg, R.,... Schröder, R. (1993). Individual risk assessment for intracranial hemorrhage during thrombolytic therapy. *Lancet*, 342(8886), 1523–1528.
- Srinivas, V.S., Hailpern, S.M., Koss, E., Monrad, E.S., & Alderman, M.H. (2009). Effect of Physician Volume on the Relationship between Hospital Volume and Mortality During Primary Angioplasty. *Journal*



- of the American College of Cardiology, 53(7), 574-579.
- Steg, P.G., James, S., Harrington, R.A., Ardissino, D., Becker, R.C., Cannon, C.P.,... Wallentin, L. (2010). Ticagrelor versus clopidogrel in patients with ST-elevation acute coronary syndromes intended for reperfusion with primary percutaneous coronary intervention: A Platelet Inhibition and Patient Outcomes (PLATO) trial subgroup analysis. *Circulation*, 122(21), 2131–2141.
- Studnek, J.R., Garvey, L., Blackwell, T., Vandeventer, S., & Ward, S. R. (2010). Association Between Prehospital Time Intervals and ST-Elevation Myocardial Infarction System Performance. *Circulation: Journal of American Heart Association*, 122, 1461-1469.
- Ting, H.H., Rihal, C.S., Gersh, B.J., Haro, L.H., Bjerke, C.M., Lennon, R.J.,... Bell, M.R. (2007). Regional systems of care to optimize timeliness of reperfusion therapy for ST-elevation myocardial infarction: the Mayo Clinic STEMI protocol. *Circulation*, 116(7), 729-736.
- Ting, H.H., Krumholz, H.M., Bradley, E.H., et al. Implementation and integration of prehospital ECG's into systems of care for acute coronary syndrome: a scientific statement from the American Heart Association Interdisciplinary Council on Quality of Care and Outcomes Research, Emergency Cardiovascular Care Committee, Council on Cardiovascular Nursing, and Council on Clinical Cardiology. *Circulation*, 2008;118:1066–1079.
- Tu, A.v., Khalid, L., Donovan, L.R., & Ko, D.T. (2008). Indicators of quality care for patients with acute myocardial infarction. *Canadian Medical Association Journal*, 179(9), 909-915.
- Van de Werf, F., Bax, J., Betriu, A., Blomstrom-Lundqvist, C., Crea, F., Falk, V.,... Weis, M. (2008). Management of acute myocardial infarction in patients presenting with persistent ST-segment elevation: the Task Force on the management of ST-segment elevation acute myocardial infarction of the European Society of Cardiology. *European Heart Journal*, 29, 2909–2945.
- Verbeek, R.P., Ryan, D., Turner, L., & Craig, A.M. (2012). Serial Prehospital 12-lead Electrocardiograms Increase Identification of ST-segment Elevation Myocardial Infarction. *Prehospital Emergency Care*, 16(1), 109-114.
- Wang, T.Y., Nallamothu, B.K., Krumholz, H.M., Li, S., Roe, M.T., Jollis, J.G.,... Ting, H.H. (2011). Association of a door-in to door-out time with reperfusion delays and outcomes among patients transferred for primary percutaneous coronary intervention. *JAMA*, 305(24), 2540-2547.
- Zia, M.I., Wijesundera, H.C., Fam, N.P., Overgaard, C.B., Dzavik, V., Lefkowitz, C.,... Radhakrishnan, S. (2008). Feasibility and safety of an early repatriation strategy for post-primary PCI patients: Insights from a multi-centre primary PCI program within the City of Toronto. Canadian Cardiovascular Congress Abstract.

Appendix A: PCI Centres in Ontario

Full Service Program (PCI & Cardiac Surgery)	Regional Transport	24/7 Operation	EMS Triage
Hamilton Health Sciences Centre	✓	✓	✓
Kingston General Hospital	✓	✓	✓
London Health Sciences Centre	✓	✓	✓
Southlake Regional Health Centre	✓	✓	✓
St. Mary's General Hospital	✓	✓	✓
St. Michael's Hospital	✓	✓	✓
Health Sciences North	✓	✓	✓
Sunnybrook Health Sciences Centre	✓	✓	✓
Trillium Health Centre	✓	✓	✓
University Health Network	✓	✓	✓
University of Ottawa Heart Institute	✓	✓	✓

Stand-Alone PCI Centres (No Cardiac Surgery Program)	Regional Transport	24/7 Operation	EMS Triage
Hôtel Dieu Grace Hospital - Windsor			
Peterborough Regional Health Centre	✓	✓	✓
Rouge Valley Health System	✓	✓	✓
Thunder Bay Regional Health Sciences Centre		✓	
William Osler Health Centre		✓	✓



Appendix B: Cardiac Care Network STEMI Working Group Membership

Madhu Natarajan*, MD, Director, Cardiac Catheterization and Interventional Labs, Hamilton Health Sciences Centre; Associate Professor, McMaster University

Andrew Affleck, MD, Emergency Physician, Base Hospital Medical Director Region 7

Julie Caffin, RN, Program Operational Director, Cardiac and Emergency Programs Kingston General Hospital

Warren Cantor, MD, Interventional Cardiologist, Southlake Regional Health Centre

Sheldon Cheskes, MD, Emergency Physician, Medical Director, Sunnybrook Centre for Prehospital Medicine

Richard Dionne, MD, Emergency Physician, The Ottawa Hospital, University of Ottawa; Associate Medical Director, Regional Paramedic Program for Eastern Ontario

Peter Dundas, Chief, Peel Regional Paramedic Services and Board Member, Ontario Association of Paramedic Chiefs (OAPC) (formerly the Association of Municipal Emergency Medical Services of Ontario [AMEMSO])

Kyle Grant†, Captain/Lead Paramedic, York Region EMS

Susan Gregoroff, RN *, Vice President Clinical Programs and Chief Nursing Executive, Cambridge Memorial Hospital

Saleem Kassam, MD, Director Cardiac Catheterization Laboratory, Rouge Valley Health System

Patrick Kennedy†, Director EMS Services, County Haliburton EMS

Michel Le May, MD, Director, Coronary Unit and Director, STEMI Program, University of Ottawa Heart Institute

Michael Lewell *†, MD, Regional Medical Director, London Health Sciences Centre, Southwestern Ontario Base Hospital

Bruce Lubelsky, MD, Cardiologist, North York General Hospital

Inderbir Singh, MD, Director, Cardiac Catheterization Laboratory and Interventional Cardiology, Trillium Health Partners

Michelle Welsford, MD, Regional Medical Director, Hamilton Health Sciences Centre for Paramedic Education & Research; Staff Emergency Physician, Hamilton Health Sciences; Associate Professor, Division of Emergency Medicine, McMaster University

Harindra Wijesundera, MD, PhD, Interventional Cardiologist, Institute for Clinical Evaluative Science (ICES) and Toronto Health Economics and Technology Assessment (THETA) Collaborative, Sunnybrook Health Sciences Centre

Ex officio Members

Kori Kingsbury, Chief Executive Officer, Cardiac Care Network of Ontario

Dan Purdham, Cardiac Care Network of Ontario

Marina Brezinov, Cardiac Care Network of Ontario

Marcella Sholdice, Cardiac Care Network of Ontario

** Member of the Survey Subcommittee*



† Left the Working Group before the environmental scan was completed.



Appendix C: Recommendations

The Working Group identified priority recommendations to address more urgent gaps in the system of care that will have the greatest impact on appropriateness, timeliness and quality of care, including:

Priority Recommendation 1: That all PCI Centres, in collaboration with Regional Base Hospitals, Emergency Medical Services and Referring Hospitals in their catchment area, develop shared and common STEMI protocols to achieve timely access to reperfusion for all patients diagnosed as or suspected of having a STEMI. All Referring Hospitals should have a STEMI protocol with linkages to a PCI Centre.

Priority Recommendation 2: That all PCI Centres, Emergency Medical Services and Referring Hospitals report every diagnosed STEMI case to the Cardiac Care Network of Ontario's cardiac registry, even if the patient is not referred for primary PCI.

Recommendation 3: That the Cardiac Care Network of Ontario STEMI protocols developed to ensure timely and appropriate diagnosis and management of STEMI patients for all remote communities be adopted as the standard of practice in Ontario, supported by Regional Base Hospitals, ORNGE, Emergency Medical Services, and PCI Centres and Referring Hospitals as well as primary care physicians.


Recommendation 4: That the Cardiac Care Network of Ontario develop a standard provincial inter-hospital agreement for the acceptance and repatriation of STEMI patients between Referring Hospitals and PCI Centres that can, in collaboration with Local Health Integration Networks and local health service providers, be adapted to local circumstances. The Ministry of Health and Long-Term Care is asked to mandate the use of these templates. Where current protocols exist for repatriation (e.g., stroke patients), the agreements could be adapted to include STEMI patients.

Recommendation 5: That the Cardiac Care Network of Ontario develop criteria for standardized discharge and repatriation practices that can be adapted for local use by all institutions that treat STEMI PCI patients, in collaboration with their local PCI provider.

Priority Recommendation 6: Ensure that the appropriate infrastructure is in place in Ontario to support timely diagnosis for STEMI patients through the following investments:

- Ensuring that all ambulances and emergency response vehicles in Ontario are equipped with cardiac monitors capable of 12-lead ECG acquisition and ensuring the development of processes for informing the nearest cardiac centre or emergency department of the results.
- Supporting the existing provincial paramedic education program for ECG acquisition and STEMI identification for all paramedics.
- Supporting Regional Base Hospitals to develop a standardized annual education program to ensure ongoing competency in ECG acquisition skill.

Recommendation 7: That every emergency department and urgent care centre in Ontario, in collaboration with the nearest PCI Centre, Regional Base Hospital and Emergency Medical Services, establish a multidisciplinary team (including emergency medicine physicians, cardiologists and nurses) to develop guideline-based, institution-specific, written protocols for triaging and managing patients suspected of or diagnosed as having STEMI.



Priority Recommendation 8: That all Emergency Medical Services establish, in collaboration with area hospital emergency departments, Regional Base Hospitals and the nearest PCI Centre, activation protocols to minimize delays in the acceptance of the patient for primary PCI and arrival of the cath lab team.

Recommendation 9: That all Emergency Medical Services, in collaboration with the Cardiac Care Network of Ontario, Regional Base Hospitals and Referring Hospitals establish local and regional guidelines and rapid transfer protocols to facilitate the timely transfer of STEMI patients directly to a PCI capable site, even when this involves bypassing a closer hospital that does not offer primary PCI.

Recommendation 10: That all Emergency Medical Services, in collaboration with the Cardiac Care Network of Ontario and Regional Base Hospitals, establish guidelines for the identification, notification and bypass to PCI Centres for transporting patients suspected of or diagnosed as having STEMI where applicable within established regions according to defined inclusion and exclusion criteria.

Recommendation 11: That all Emergency Medical Services establish direct transfer agreements with all area hospitals for the inter-hospital transfer of STEMI patients. These agreements should recognize the emergent nature of these transfers.

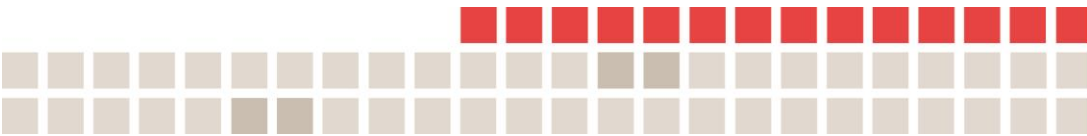
Recommendation 12: That the Cardiac Care Network of Ontario develop standardized protocols for the treatment of patients (e.g., antiplatelet and post-lytic management) suspected of or diagnosed as having a STEMI while awaiting transport to a PCI Centre.

Priority Recommendation 13: That health service providers, including Emergency Medical Services, with the support of their Local Health Integration Network, enable the real-time exchange of data for STEMI patients between EMS, other medical facilities and clinics, Referring Hospitals and PCI Centres, including the provision of 12-lead ECG on arrival at the accepting PCI Centre.

Recommendation 14: That all PCI Centres, in collaboration with their Local Health Integration Network, Emergency Medical Services, Regional Base Hospitals and Referring Hospital partners, develop a regional STEMI network to ensure rapid access to appropriate care for all patients diagnosed as or suspected of having a STEMI. All hospitals that treat STEMI patients should be part of a regional STEMI network, in partnership with a PCI Centre (hub-and-spoke model).

Recommendation 15: That the Cardiac Care Network of Ontario, with the support of the Ministry of Health and Long-Term Care, develop a provincial quality assurance program for the care of all STEMI patients. The program should define the indicators to be monitored and the data definitions for those indicators. The data definitions and quality indicators used for this program should be consistent with the pan-Canadian data definitions and quality indicators recently developed by the Canadian Cardiovascular Society and the Cardiac Care Network of Ontario.

Recommendation 16: That the Cardiac Care Network of Ontario, with the support of the Ministry of Health and Long-Term Care, add the data needed for the quality assurance program to its provincial cardiac database and develop protocols for the collection, monitoring and reporting of all STEMI cases across the Province.



Appendix D: PCI Hospital Survey

For the purposes of this survey, please use the following definitions:CCU – Coronary Care Unit
 ED – Emergency Department
 LBBB – Left Bundle Branch Block
 In-House – PCI Centre
 ICU – Intensive Care Unit
 PCI (Angioplasty) – **threading a balloon-tipped catheter through the arterial system and into the obstructed coronary artery. A balloon is inflated to force the plaque against the arterial wall to open the artery.**
 Primary PCI - **performing acute PCI immediately for the treatment of a STEMI as the primary form of reperfusion.**
 Rescue PCI - **performing PCI for STEMI after fibrinolytics have been given but *have failed to reperfuse the infarct related artery.* The decision to perform rescue PCI is generally made 60-90 minutes following the administration of fibrinolytics.**
 Pharmacoinvasive PCI - **A planned PCI after fibrinolysis therapy. Direct transfer to the cath lab is already planned at the time the fibrinolysis therapy is administered. The transfer to the cath lab is not dependent on the response to the fibrinolysis therapy.**
 STEMI – **ST segment elevation myocardial infarction (MI)**
 Walk in – **A patient that self-transported to ED of a PCI centre**

Respondent Contact Information

Name:

Phone number:

Email address:

General Questions:

Hospital Name: _____

1. Total number of acute care beds within the organization (please check only one response):

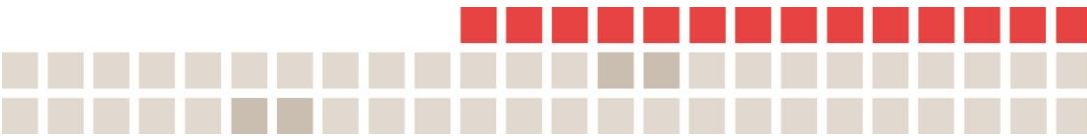
- < 50
- 50 – 99
- 100 – 199
- 200 – 399
- >= 400

2. What is the total number of critical care beds? _____



STEMI Management

3. Total number of Emergency Department visits/year (2010/2011 actual): _____
4. Do you have a STEMI protocol in place?
- Yes (please send electronic version to mbrezinov@ccn.on.ca)
 - No
5. In your STEMI algorithm is suspected new LBBB part of criteria for PPCI?
- Yes
 - No
6. What ED quality indicators do you actively monitor as it relates to STEMI management (check all that apply)
- Triage to ECG time interval
 - Arrival to ED to Cath lab activation time
 - Arrival to ED to departure/transfer to cath lab time interval (DIDO)
 - Other _____
 - Not applicable (check only if you do not monitor ER quality indicators)
7. If you do not offer 24/7 Primary PCI at your institution, please rank the following barriers most frequently occurring (5) to least frequently occurring (1)?
- Physical resources
 - Human resources
 - Lack of repatriation agreements with Non-PCI hospitals
 - Lack of hospital administration support
 - Financial
 - Credentials/training
8. What type of coverage does your hospital provide for STEMI patients requiring emergent PCI?
- 100%, 24/7 that includes PCI center walk-ins, EMS and non-PCI hospital patients who are transferred to the cath lab
 - 100%, 24/7 for admitted walk-in patients only
 - 100%, 24/7 for walk-ins and EMS patients only
 - 100%, 24/7 for walk-ins and Non-PCI regional patients
 - Monday to Friday only during operational cath lab hours
 - Other, please describe: _____



9. The decision making process on reperfusion strategy at the non-PCI centres in your region is:

- Prescriptive – PCI centre has established each non-PCI hospital what treatment to offer their walk-in patients (i.e. PPCI or Lytics)
- Discretionary – Each non-PCI centre decides if they prefer to give thrombolysis or activate the cath lab team for Primary PCI
- PCI services are not offered to non-PCI hospitals in our region
- Other _____

10. What type of reperfusion strategy does your hospital provide for in-house STEMI patients?

- All in-house STEMI patients receive PPCI
- All in-house STEMI patients receive thrombolysis and Rescue PCI if needed
- All in-house STEMI patients are provided with Pharmacoinvasive PCI option
- There is no standardized reperfusion strategy in place for STEMI patients
- Other _____

11. What is the dominant reperfusion strategy your hospital offers to STEMI patients that are transferred or walk-in to an ED of a Non-PCI hospital in your region?

- All STEMI patients receive PPCI
- All STEMI patients receive thrombolysis and Rescue PCI if needed
- All STEMI patients are provided with Pharmacoinvasive PCI option
- Time-based model in which patients from non-PCI hospitals are divided according to their time-to-travel to PCI centre.
- There is no standardized reperfusion strategy in place for non PCI hospitals in our region
- Other _____

12. What type of reperfusion therapy does your hospital offer to patients diagnosed with STEMI by EMS in your region?

- All STEMI patients are transferred directly to PCI center
- All STEMI patients are transferred to the closest acute hospital for thrombolysis
- Time-based model in which patients from the field are treated according to their time-to-travel to PCI centre; patients are offered either Primary, Rescue or Pharmacoinvasive PCI
- There is no standardized reperfusion strategy in place for STEMI patients diagnosed in the field in our region
- Other _____

13. How are the potential Primary PCI cases get referred to the cath lab?

- The team is activated through centralized call system directly from the field or ED (without interventionalists or cardiologist consult)
- The team is activated by the interventionalist on call after discussion has taken place with ED physician or EMS paramedic
- All cases go through the triage coordinator
- Not applicable (check only if you do not provide PPCI)
- Other _____

14. How are the potential Rescue PCI cases get referred to the cath lab?

- The team is activated through centralized call system directly from the ED (without interventionalist or cardiologist consult)
- The team is activated by the interventionalist on call after discussion took place with ED physician
- All cases go through the triage coordinator
- Not applicable
- Other _____

15. How are the potential Pharmacoinvasive PCI cases referred to the cath lab?

- The team is activated through centralized call system directly from the ED (without interventionalist or cardiologist consult)
- The team is activated by the interventionalist on call after discussion took place with ED physician
- All cases go through the triage coordinator
- Not applicable
- Other _____

In-house post PCI management

16. Where do STEMI patients go immediately post Emergent PCI for recovery most often?

- Telemetry unit
- CCU/ICU
- Cath lab recovery
- General medical floor/unit
- All patients are assessed post procedure and transferred to either critical care bed or telemetry unit
- Other, please specify: _____

17. How long do STEMI patients stay in critical care bed post procedure?



- < 6 hours post procedure
- 6 – 12 hours post procedure
- >12 and <18 hours post procedure
- 24 hours post procedure
- All STEMI patients are discharged from CCU

18. Do you use early discharge scoring (e.g. Zwolle score) to facilitate the discharge of PPCI patients in your centre?

- Yes
- No
- Other _____

19. What is the typical LOS post procedure at your institution:

- 48 hours
- 72 hours
- 5 days
- Other
- Unknown _____

20. Upon discharge, which of the following secondary prevention strategies are most commonly in place? Check all that apply.


- ASA
- Anti-platelet therapy
- Statins
- ACEi/ARB
- Cardiac rehab referral
- Education on risk factor modification
- Other _____

Repatriation protocols

21. Do you have repatriation agreements with the non PCI centres in your region?

- Yes with all
- Only with some Non-PCI centres in our region
- No
- Not applicable (check only if you keep all your STEMI patients)

22. What is the recovery period at your centre prior to repatriation?

- 
- < 6 hours post procedure
 - 6 – 12 hours post procedure
 - >12 and <16 hours post procedure
 - > 16 hours post procedure
 - Not applicable (check only if you do not repatriate patients)
 - Other _____

23. Do you provide post procedure/discharge recommendations to the non-PCI centre?

- Yes
- No

24. Do you use early discharge scoring (e.g. Zwolle score) to facilitate repatriation and discharge recommendations for non-PCI centres in your region?

- Yes
- No
- Other _____

25. Please rank the following barriers to repatriating patients post PCI in order of most frequently occurring (5) to least frequently occurring (1)?

- Availability of critical care beds
- Availability of telemetry beds
- Availability of physicians accepting transfers
- Lack of knowledge and expertise of post PCI patients' management
- Availability of EMS for inter-hospital transfer
- Not applicable

Quality Assurance Program

26. Do you track post procedure outcomes for admitted patient to your institution?

- Yes
- No

27. How do you track post procedural outcome information for STEMI patients repatriated back to a Non-PCI hospital?

- We do not receive outcome information post repatriation
- There is an informal process for reporting of deaths and major adverse events post repatriation
- Each non-PCI hospital in our region sends a monthly report on the discharge status and major adverse event on all their patients



- Not applicable (check only if you do not repatriate patients back)
- Other _____

28. If you do not offer 24/7 Primary PCI at your institution, please rank the following barriers most frequently occurring (5) to least frequently occurring (1)?

- Physical resources
- Human resources
- Lack of repatriation agreements with Non-PCI hospitals
- Lack of hospital administration support
- Financial
- Credentials/training

Management of patients with ROSC following cardiac arrest

29. Do you accept intubated STEMI patients post active resuscitation for emergent PCI?

- Yes
- No

30. If you accept intubated patients, what is the current transfer protocol?

- Accept patient directly to cath lab
- Accept patients to PCI hospital ER for stabilization and then transfer to cath lab
- Our centre does not accept intubated patients

31. If patient requires cooling, when do you initiate it?

- Post PCI after transfer to ICU/CCU
- In the cath lab during the procedure
- Not applicable (check off only if there is no protocol in place)
- Other _____

Appendix E: Referring Hospital Survey

For the purposes of this survey, please use the following definitions:

CCU – Coronary Care Unit
ED – Emergency Department
In-House – PCI Centre
ICU – Intensive Care Unit
MOU – Memorandum of Understanding (a document describing a bilateral or multilateral agreement between parties/hospitals).
PCI (Angioplasty) – threading a balloon-tipped catheter through the arterial system and into the obstructed coronary artery. A balloon is inflated to force the plaque against the arterial wall to open the artery.
Primary PCI - performing acute PCI immediately for the treatment of a STEMI as the primary form of reperfusion.
Rescue PCI - performing PCI for STEMI after fibrinolytics have been given but *have failed to reperfuse* the infarct related artery. The decision to perform rescue PCI is generally made 60-90 minutes following the administration of fibrinolytics.
Pharmacoinvasive PCI - A planned PCI after fibrinolysis therapy. Direct transfer to the cath lab is already planned at the time the fibrinolysis therapy is administered. The transfer to the cath lab is not dependent on the response to the fibrinolysis therapy.
STEMI – ST segment elevation myocardial infarction (MI)
Walk in – A patient that self-transported to ED of a PCI centre

Non PCI hospital

For hospital corporations with more than one site please complete survey for each location
Respondent Contact Information

Name:

Phone number:

Email address:

General Information

1. Total number of acute care beds within the organization (please check only one response):

- < 50
- 50 – 99
- 100 – 199
- 200 – 399
- >= 400



2. Please indicate which of the following cardiac services your facility currently provides. Please check off all that apply.

- Emergency Treatments
- Intensive/Coronary Care Inpatient Unit
- Telemetry Inpatient Unit
- Medical inpatient unit
- Other _____

3. Which PCI hospital(s) do you have MOU or any formal arrangements with: Please check all that apply.

- Hamilton Health Science Centre
- Health Science North (Hotel Regional de Sudbury)
- Hotel-Dieu Grace Hospital
- Kingston General Hospital
- London Health Sciences Centre
- Peterborough Regional Health Centre
- Rouge Valley Health System (Centenary)
- St. Mary's General Hospital
- St. Michael's Hospital
- Southlake Regional Health Science Centre
- Sunnybrook Health Science Centre
- Thunder Bay Regional Health Science Centre Trillium Health Centre
- University Health Network
- University of Ottawa Heart Institute
- William Osler Health Centre
- Not applicable
- Other _____

4. Do you have a tripartite agreement with EMS, PCI hospital and your facility for inter-hospital transfers?

- Yes
- No

5. Do you have a cardiology department at your facility?

- Yes
- No

6. Number of Internists with privileges in your facility: _____

7. Number of Cardiologists with privileges in your facility: _____

8. Do you have a cooling protocol in place?

- Yes (if yes, please attach the electronic version)
- No

9. Do you transfer patients for Emergent PCI with cooling underway?

- Yes
- No
- Not applicable (check only if you do not cool patients at your hospital)

ED operation questions:

10. Total number of Emergency Department visits/year (2010/2011 actual): _____

11. Does your Emergency Department have a physician on site 24/7?

- Yes
- No
- Not applicable

12. Do you have a STEMI protocol in place?

- Yes (please attach electronic version)
- No

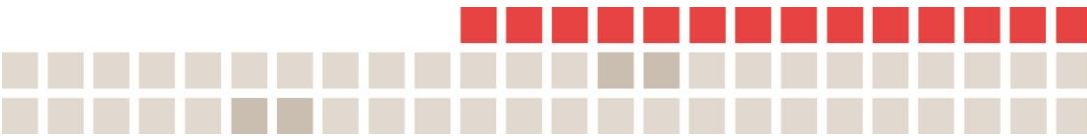
13. What ED quality indicators do you actively monitor as it relates to STEMI management?
(check all that apply)

- Triage to ECG time interval
- Arrival to ED to Cath lab activation time
- Arrival to ED to departure/transfer to cath lab time interval (DIDO)
- Other _____
- Not applicable (check only if you do not monitor ED quality indicators)

14. Do you actively monitor and report ED door to needle times?

- Yes
- No
- Not applicable (check only if all your patients are transferred for PPCI)

13. What is the primary STEMI reperfusion strategy at your facility?



- STEMI patients transferred to a PCI centre for PPCI
- STEMI patients receive thrombolysis followed by immediate transfer to a PCI centre (patients with contraindications are managed as PPCI)
- STEMI patients receive thrombolysis and are transferred to a PCI centre if needed for a rescue PCI
- There is no STEMI protocol in place. Patients are managed according to their clinical status
- Other _____

15. What is the backup strategy if your primary strategy is not accessible?

- Yes
- No

16. What are the resources that you have in place to manage patients that do not meet the pre set STEMI criteria (i.e. borderline ECG)?


- Interventional cardiologist on call is available for consult
- All patients are managed with local resources only and system is activated once patient reached STEMI criteria
- Other _(please describe) _____

17. For patients that require thrombolysis administration in ED, do you have a protocol or an order set in place for patient management post drug administration (e.g. repeat ECGs or blood work)

- Yes
- No

18. Which hospital(s) do you commonly refer patients to for Primary, Rescue or Pharmacoinvasive PCI? Please check all that apply.

- Hamilton Health Science Centre
- Health Science North (Hotel Regional de Sudbury)
- Hotel-Dieu Grace Hospital
- Kingston General Hospital
- London Health Sciences Centre
- Peterborough Regional Health Centre
- Rouge Valley Health System (Centenary)
- St. Mary's General Hospital
- St. Michael's Hospital
- Southlake Regional Health Science Centre

- 
- Sunnybrook Health Science Centre
 - Thunder Bay Regional Health Science Centre Trillium Health Centre
 - University Health Network
 - University of Ottawa Heart Institute
 - William Osler Health Centre
 - Other _____

19. Please rank the barriers that you encounter in order of most frequently occurring (5) to least frequently occurring (1)? When transferring patients emergently to a PCI hospital?

- Availability of critical care beds at PCI centre
- Availability of nursing staff to accompany STEMI patient
- Availability of physicians accepting transfers
- Availability of EMS for inter-hospital transfer
- Not applicable (check only if you do not encounter any barriers)
- Other unique barriers that have not been addressed _____

20. What is the method of transfer most often used?

- EMS
- Air ambulance
- CritiCall
- Private ambulance
- Other _____

21. What level of expertise is required by your facility to transfer a STEMI patient?

- EMS
- EMS with ACLS certified RN
- Private ambulance with ACLS certified RN
- CritiCall
- Air Ambulance
- Other _____



Post PCI Management:

22. Do you have repatriation agreements with PCI hospitals? Check all that apply.

- Hamilton Health Science Centre
- Health Science North (Hotel Regional de Sudbury)
- Hotel-Dieu Grace Hospital
- Kingston General Hospital
- London Health Sciences Centre
- Peterborough Regional Health Centre
- Rouge Valley Health System (Centenary)
- St. Mary's General Hospital
- St. Michael's Hospital
- Southlake Regional Health Science Centre
- Sunnybrook Health Science Centre
- Thunder Bay Regional Health Science Centre Trillium Health Centre
- University Health Network
- University of Ottawa Heart Institute
- William Osler Health Centre
- Not applicable
- Other _____

23. When do you accept patients post Primary, Rescue or Pharmacoinvasive PCI?

- <6 hours post procedure
- 6 – 12 hours post procedure
- >12 and < 16 hours post procedure
- > 16 hours post procedure
- Not applicable (check only if currently do not accept patients post procedure)
- Other _____

24. Where do you most often admit repatriated patients to?

- Critical care bed
- Telemetry bed
- Medical bed
- Not applicable (check only if currently do not accept patients post procedure)
- Other _____



25. Do you have a post repatriation order set/protocol in place?

- Yes
- No
- Not applicable (check only if currently do not accept patients post procedure)

26. Do you use early discharge scoring system (e.g. Zwolle score) to facilitate the discharge of PPCI patients?

- Yes
- No
- Other _____
- Not applicable (check only if currently do not accept patients post procedure)

27. What is the most frequent barrier to accepting patients post PCI?

- Availability of critical care beds
- Availability of telemetry beds
- Availability of physicians accepting transfers
- Lack of knowledge and expertise of post PCI patients' management
- Availability of EMS for inter-hospital transfer
- Not applicable
- Other _____

28. Upon discharge, which of the following secondary prevention strategies are most commonly in place? Check all that apply.

- ASA
- Anti-platelet therapy
- Statins
- ACEi/ARB
- Cardiac rehab referral
- Education on risk factor modification
- Other _____



Appendix F: EMS Survey

General Information

1. Name of your EMS service:

2. Name the Base Hospital that your service is affiliated with:

3. What is the total population of the municipality/county that you serve? _____

4. How many *total* calls do you respond to per year (2010/2011)? _____

5. What % of your call total volume are your crews being dispatched as CODE 4 lights and sirens?

6. How many of the *total* calls that you respond to per year are for cardiac chest pain based upon final problem code recorded by transporting crew? _____

7. Do you use electronic or paper ACR? _____

8. Please provide number of paramedics with the following designation (check all that apply):

PCP _____

ACP _____

CCP _____

Total paramedics _____

9. How many ambulances are active within your service?

Night shift _____

Day shift _____

Weekend night shift _____

Weekend day shift _____

Total _____

10. Do you have pre-hospital 12-lead ECG capabilities?

No vehicles are equipped with 12-lead

Some are (please define) _____

All Vehicles

- 
- Only ACP vehicles

11. If no 12-lead capability currently, do you anticipate acquiring this capability within the next 12 months?

- Yes
- No

12. Have your paramedics been trained to interpret 12-lead ECG's?

- Yes – PCP and ACP (if present) paramedics interpret 12-lead ECG
- Yes – however paramedics follow automatic/machine interpretation
- Yes- ACP only, not the PCP
- No- none of our paramedics have had training on 12 lead interpretation
- Not applicable (indicate only if there are no 12-lead ECG capabilities)

STEMI management and protocols

13. Once a STEMI is diagnosed in the field, do you give pre-hospital notification to the interventional cardiology team of inbound STEMI patients?

- Yes
- No
- Not applicable (check off only if cannot diagnose STEMI in the field)

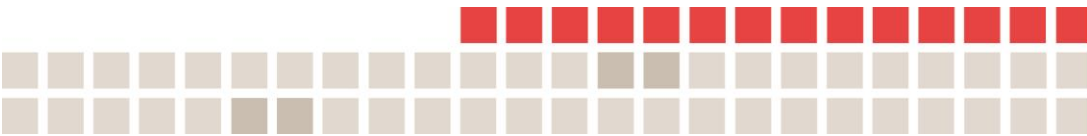
14. Once a STEMI is diagnosed in the field, is the cath lab team activated by paramedics from the field after hours?

- Yes
- No
- Not applicable (check off only if cannot diagnose STEMI in the field)

15. Do you have STEMI protocol in place?

- Yes for ACP and PCP
- Yes for ACP only
- Yes for PCP only
- No not at all
- No, but anticipate one within 12 months

16. What is the maximum DRIVE TIME in minutes (or km) allowed by your protocol from scene to PCI hospital? _____



17. Do you have a STEMI protocol that specifically includes ORNGE?

- Yes
- No

18. How do you make the diagnosis in the field of STEMI?

- Computer software interpretation of “Acute MI”
- Paramedic based interpretation PCP and ACP
- Paramedic based interpretation ACP only
- Transmission to ED MD or BHP for interpretation
- Transmission to Interventional Cardiologist for interpretation
- Other _____

19. How do ACPs make the diagnosis in the field of STEMI?

- Computer software interpretation of “Acute MI”
- Paramedic based interpretation PCP and ACP
- Paramedic based interpretation ACP only
- Transmission to ED MD or BHP for interpretation
- Transmission to Interventional Cardiologist for interpretation
- Other _____

20. Do you include Left Bundle Branch Block as an indication for STEMI activation?

- Yes
- No

21. Do you have contraindications to PCI transport? (Vital sign parameters etc....) If yes, please list _____

22. When STEMI is diagnosed in the field, what is your current protocol?

- All STEMI diagnosed patients are transferred directly to a cath lab for PPCI
- Hybrid model in which patients that are within specified distance from the PCI centre are either taken directly to the cath lab for PPCI or to the closest ED for thrombolysis administration
- All patients are transferred to the nearest ED for thrombolysis administration
- Not applicable (check only if you cannot diagnose STEMI in the field)

Other _____

23. Do you give pre-hospital thrombolytics?

- Yes
- No
- Yes within a randomized control trial

24. Do you utilize post ROSC therapeutic hypothermia for cardiac arrest patients in the field?

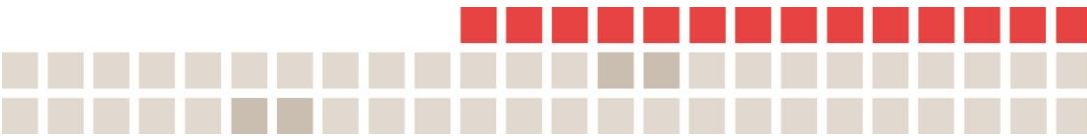
- Yes (if yes, please attach the electronic version of your protocol)
- No

25. To which hospital(s) do you most commonly transfer patients for Primary, Rescue or Pharmacoinvasive PCI? Please check all that apply.

- Health Sciences North
- Kingston General Hospital
- University of Ottawa Heart Institute
- St. Michael's Hospital
- St. Mary's General Hospital
- University Health Network
- Trillium Health Centre
- Hamilton Health Science Centre
- London Health Science Centre
- Southlake Regional Health Science Centre
- Scarborough Hospital
- Sunnybrook Health Science Centre
- Rouge Valley Health System
- Hotel-Dieu Grace Hospital
- Thunder Bay RHSC
- Not applicable (check only if you do not transfer STEMI patients directly to the cath lab)

26. Which hospital(s) do you have a MOU with? Please check all that apply.

- Sudbury Regional
- Kingston Regional
- Ottawa Heart Institute
- St. Michael's
- St. Mary's
- University Health Network
- Trillium Health Centre
- Hamilton Health Science Centre
- London Health Sciences Centre
- Southlake Regional Health Science Centre



- Sunnybrook Health Science Centre
- Rouge Valley Health System
- Hotel-Dieu Grace Hospital
- Thunder Bay RHSC
- Not applicable (check only if you do not have any agreements in place)

27. If you DO NOT have a MOU in place, please indicate which PCI site is nearest.

- Sudbury Regional
- Kingston Regional
- Ottawa Heart Institute
- St. Michael's
- St. Mary's
- University Health Network
- Trillium Health Centre
- Hamilton Health Science Centre
- London Health Science
- Southlake Regional Health Science Centre
- Sunnybrook Health Science Centre
- Rouge Valley Health System
- Hotel-Dieu Grace Hospital
- Thunder Bay RHSC
- Not applicable (check only if you do not have a PCI centre with 60 km radius)

28. Do you have a system or agreement in place with bordering municipalities when STEMI patients need to bypass acute care hospitals and they must be transferred across municipal borders?

- Yes
- No
- Not applicable

29. If you DO NOT have a STEMI bypass protocol in place, what is the biggest barrier to developing it in your service area?

- Equipment/Technology
- Human Resources
- Credentials/training
- Financial
- Communication/Coordination
- Legal
- Geographic – too great a distance to PCI capable centre

Other: _____ \

30. Do you have a dedicated QA process to monitor performance of your STEMI bypass system?

- Yes
- No

31. If your system monitors E2B times (EMS to balloon) what start point do you use for EMS contact time

- 911 call
- EMS arrive scene time
- EMS arrive patient
- First ECG
- First qualifying ECG

32. If your system monitors E2D times (EMS contact to door) what “door” do you use?

- Arrive PCI hospital
- Arrive PCI Lab
- On cath lab table

33. Does your system measure “false positive” cath lab activation

- Yes
- No

34. If so, what is considered a “false positive”?

- Medic followed protocol and no cath performed
- Medic did not follow protocol and no cath performed
- Medic followed protocol and no “culprit lesion” noted at cath

STEMI Inter-facility transfers

35. Do you currently have or operate a dedicated ambulance assigned to inter-facility STEMI transfer service?

- Yes
- No

36. In 2010/2011 what was the number of STEMI emergency inter-facility transfers? (Acute-care hospital to acute-care hospital/ STEMI only).



37. What is your response time (call placed to arrival of crew) for inter-facility transfer of STEMI patients?

38. Does your system measure sending hospital DIDO (door in door out times?)

- Yes
- No

39. Does your system measure time from first hospital triage to PCI hospital balloon time?

- Yes
- No

40. If your system measures sending hospital DIDO times what is the start time of this measure?

- Triage time
- First ECG
- First Qualifying ECG

41. Does your region have a standardized process for STEMI inter-facility transfers of walk in STEMI patients?

- Yes
- No

42. Does your system allow STEMI transfers of patient by paramedics at the PCP level?

- Yes
- No

43. If yes to PCP STEMI transfers, are they done

- Without escort (PCP alone)
- With escort (MD or RN)
- NA

44. For STEMI inter-facility transfers, are appropriate transfer vehicles readily available within the following time frames?

- 0-10min
- 10-20min
- 20-30min

LHIN 1: Erie St. Clair

CCN Member Hospital: Hôtel-Dieu Grace Hospital

CARDIAC PROGRAM TYPE	SERVICE MODEL	■ = PROVIDED ■ = NOT PROVIDED	
Cardiac Catheterization and PCI Program	■ Regional Transport	■ 24/7 Operations	■ EMS Triage Support

Program Overview

Hôtel-Dieu Grace Hospital (HDGH) has implemented a stand-alone angioplasty program for the Southwest Ontario region, serving primarily Windsor and Essex County. Since 2007, the program has expanded to include two interventional cardiologists and a 12-hour operational day. The hospital also has a daytime primary PCI since 2010.

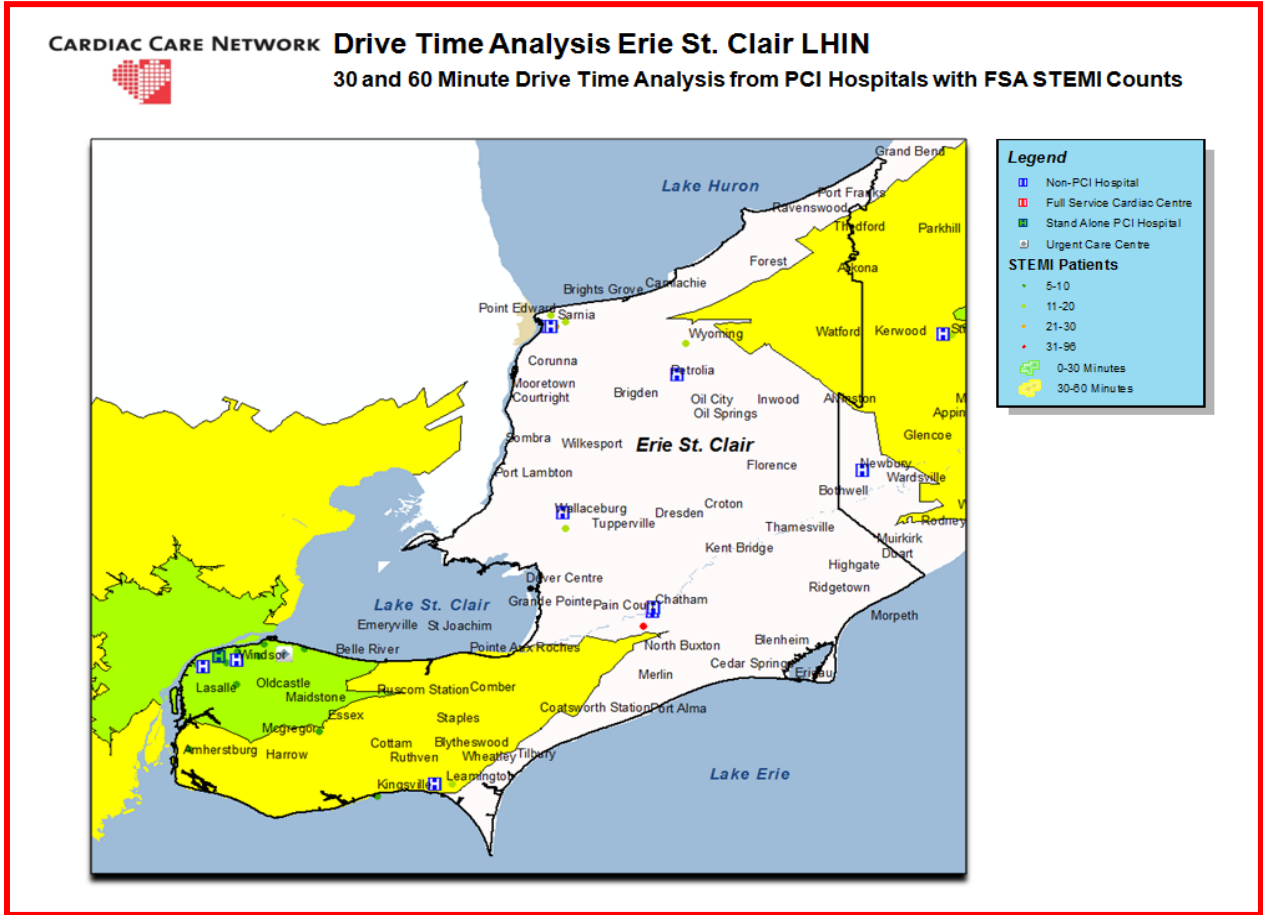
HDGH is currently seeking approval for expansion through the construction of an additional wing that will include a two-suite angioplasty lab to allow for a third interventional recruit and 24/7 primary PCI program.

Highlights

- Stand-alone program established May 2007 with rotation of physicians from London Health Sciences Centre.
- Medical Director recruited, leading program at HDGH March 2008.
- Second Interventionalist recruited and joined the team May 2010.
- Current patient population served is primarily Windsor and Essex County. (Windsor Regional Hospital and Leamington District Memorial Hospital).
- Primary PCI offered during daytime hours but process is not formalized.
- On-site pre- and post-PCI clinic established 2008.
- Integrated intravascular ultrasound (IVUS) program established October 2009 decreasing need for additional transfers to London.
- Collaboration with Schulich Medical School – cardiology residents rotate in lab.
- Collaborative revascularization rounds held weekly via videoconference with LHSC reviewing complicated patient cases.
- Strong commitment to fundraising to support cath lab expansion project with over \$8 million raised thus far.
- Long-term plan for administering lytics and immediate transfer for Chatham/Kent region, but currently unable to accommodate influx of patients due to limited CCU beds and cath lab capacity.



Figure D-1: Drive Analysis and STEMI Incidence Map (Erie St. Clair), 2011/12



Source: CCN, using CIHI DAD, 2011/12

LHIN 2: South West

CCN Member Hospital: London Health Sciences Centre

pPCI Program Service Level:

CARDIAC PROGRAM TYPE	SERVICE MODEL	■ = PROVIDED ■ = NOT PROVIDED	
Full Service PCI and Cardiac Surgery Program	■ Regional Transport	■ 24/7 Operations	■ EMS Triage Support

Program Overview

The primary PCI program is a partnership between London Health Sciences Centre, Thames EMS, the Southwest Ontario Regional Base Hospital, the Central Ambulance Communication Centre and the London-Middlesex County Department of Emergency Services. Its purpose is to treat patients experiencing an ST elevation myocardial infarction (STEMI) within 90 minutes of the onset of chest pain.

BCLS and ACLS paramedics based in Middlesex County have been trained to interpret 12-lead electrocardiograms (ECGs) performed in the community. Once a potential STEMI has been diagnosed, EMS communicates directly with the interventional cardiologist on call who makes the final diagnosis and assembles the primary PCI team in the cardiac catheterization lab at University Hospital, a site of London Health Sciences Centre. As the primary PCI team is assembling in the lab, the patient is transported directly to the cath lab bypassing EDs along the route using a bypass protocol. The ability of basic and advanced life saving (BCLS and ACLS) paramedics to interpret 12-lead ECGs, and initiate contact with the Interventionalist on call, has been in effect for a year.

Plans are underway to expand the program to better serve STEMI patients in surrounding communities.

Oxford, Perth, Elgin, Middlesex Counties have all signed bypass agreements including them in the Code STEMI program for patients within the 30-minute drive time (the decision as to drive time has been left with EMS). If the patient presents by EMS in these regions, EMS will bypass the local hospital and bring the patient directly to University Hospital. If the patient self presents to these regional hospitals, it was decided that they should be treated as pharmacoinvasive, and the University Hospital would guarantee their acceptance. This was decided due to very high transport times of 2-3 hours resulting in significant treatment delays. Patients who do not qualify for fibrinolysis therapy are accepted for primary intervention.

Huron County was approached about entering the STEMI Program for those within the 30-minute drive time; however, the one hospital that would need to sign the bypass agreement was not willing to do so. We have, therefore, offered to engage in pharmacoinvasive treatment for all Huron County STEMI patients as the best possible alternative given the situation.

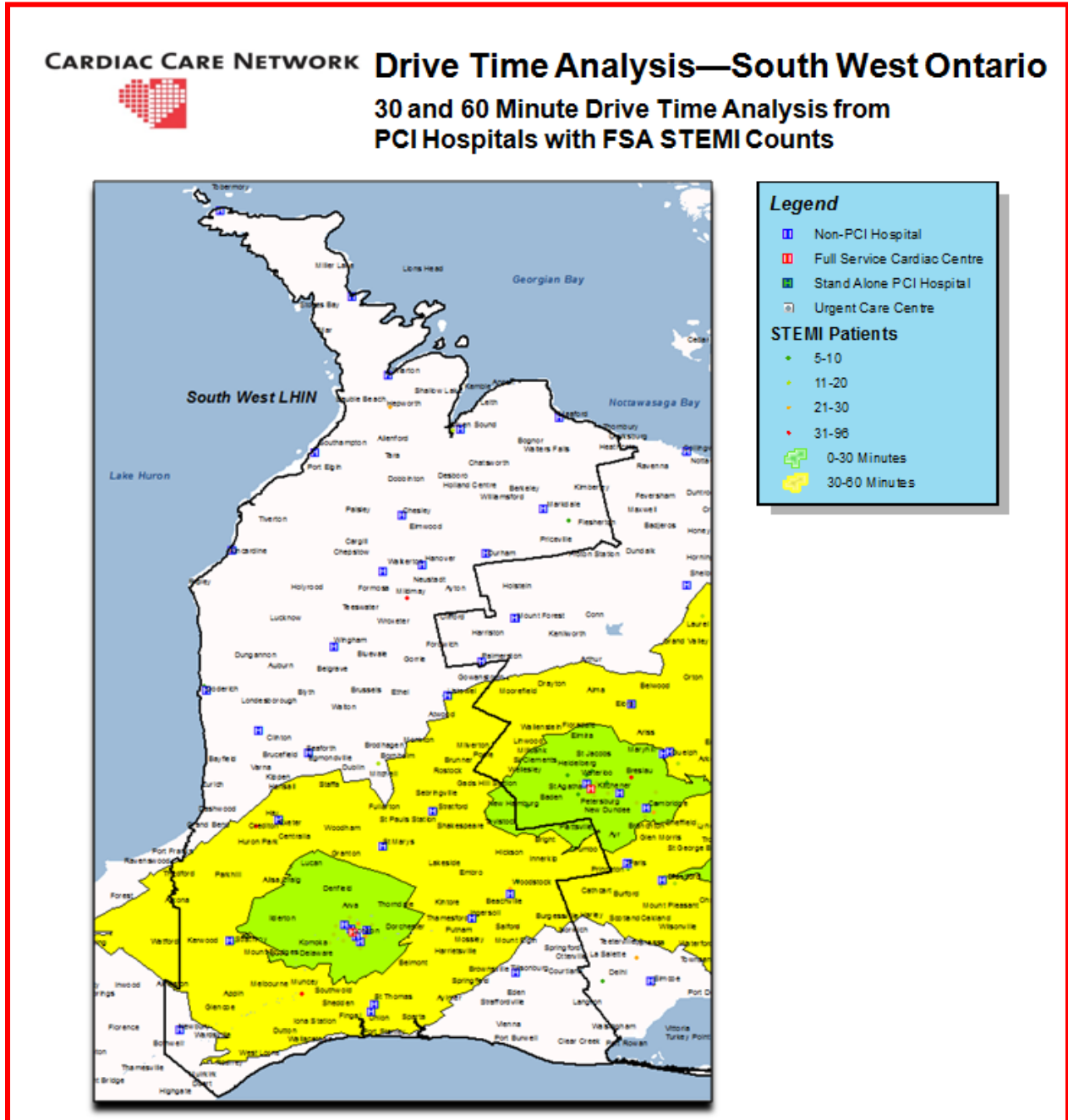
Highlights

- The original program was implemented in 2006. It has expanded three times to better serve our patient population. We currently offer service 24 hours a day, 7 days a week to the residents of London regardless of whether they call 911, present at their local emergency department, or have a STEMI while an inpatient of a local hospital.
- Middlesex County hospitals outside of London are treated as pharmacoinvasive.



- The program serves a population of 460,000.

Figure D-2: Drive Analysis and STEMI Incidence Map (South West), 2011/12



Source: CCN, using CIHI DAD, 2011/12

LHIN 3: Waterloo Wellington

CCN Member Hospital: St. Mary's General Hospital

CARDIAC PROGRAM TYPE	SERVICE MODEL	■ = PROVIDED ■ = NOT PROVIDED	
Full Service PCI and Cardiac Surgery Program	■ Regional Transport	■ 24/7 Operations	■ EMS Triage Support

Program Overview

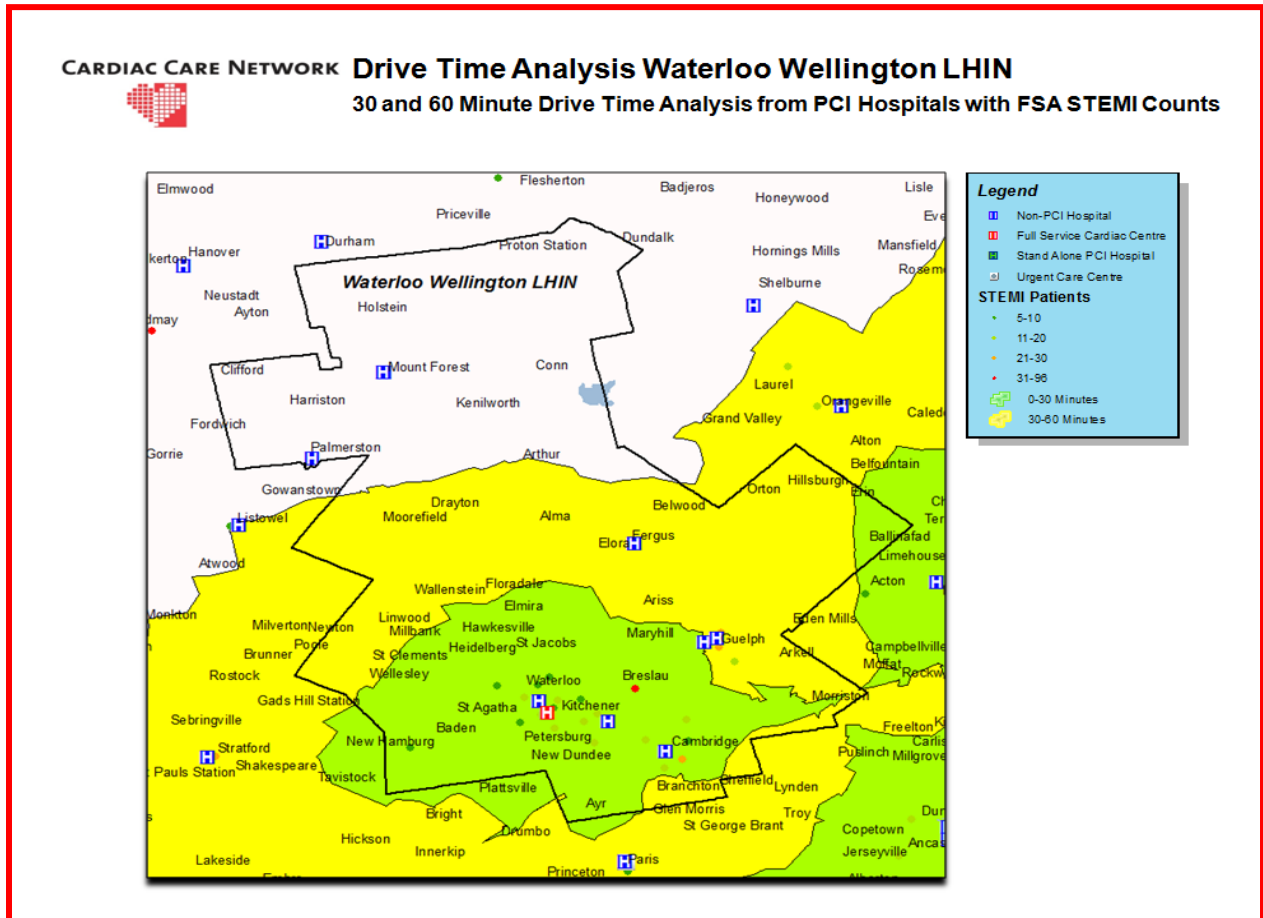
St. Mary's General Hospital provides a regional approach to STEMI care where patients are admitted directly to the cath lab for primary angioplasty. The program is a partnership between St. Mary's Regional Cardiac Centre and the Region of Waterloo EMS. St. Mary's General Hospital has provided advanced ECG training and a train-the-trainer program to all Region of Waterloo EMS paramedics. EMS has developed a STEMI Protocol and Directive that allows paramedics to make the diagnosis from the 12-lead ECG, to call direct to St. Mary's Cath Lab and to activate the STEMI Protocol. The External Code STEMI protocol allows advanced care paramedics to review the results of the 12-lead ECG and activate the team at St. Mary's directly. The interventional cardiologist speaks with the EMS on route, and if appropriate, the patient bypasses the hospital's ED and proceeds directly to the cardiac cath lab. The External Code STEMI protocol operates 24/7.

Highlights

- The St. Mary's program was implemented in 2007.
- The program operates within southwestern Ontario, a mix of rural and urban geography that covers 4,800 square kilometers with a population of 750,000.
- The program received the Ontario Hospital Association Best Award in Use of Technology as a "first" in Canada to adopt wireless RIM technology for diagnosing STEMI.
- Recently, EMS paramedics have received advanced training and now do a diagnosis in the field and implement the Code STEMI Protocol directly. They call one STEMI number, which activates the on-call team and communication with the interventional cardiologist.



Figure D-3: Drive Analysis and STEMI Incidence Map (Waterloo Wellington), 2011/12



Source: CCN, using CIHI DAD, 2011/12

LHIN 4: Hamilton Niagara Haldimand Brant

CCN Member Hospital: Hamilton Health Sciences Centre

pPCI Program Service Level:

CARDIAC PROGRAM TYPE	SERVICE MODEL	■ = PROVIDED ■ = NOT PROVIDED	
Full Service PCI and Cardiac Surgery Program	■ Regional Transport	■ 24/7 Operations	■ EMS Triage Support

Program Overview

Hamilton Health Sciences – General Site (HGH) is the PCI site for LHIN 4 (HNHB LHIN). The primary PCI program began in 2003 with primary PCI initially offered to patients presenting at the HGH during cath lab operational hours. The current model deals with two types of patients:

- Patients in Hamilton and Burlington presenting to EMS, where a 12-lead ECG demonstrates STEMI, are transported directly to the HGH. Expansion of the direct field-to-HGH transfer to other 5 EMS services of the LHIN is in progress..
- For patients presenting by self-transportation, or by EMS where no ECG is obtained in the field, primary PCI is offered 24/7 where immediate transportation is available, or for high risk STEMI and fibrinolysis therapy contraindication patients. In this latter group, once the STEMI is diagnosed by the Emergency Physician; the Interventionalist on call is notified via the “PCI Hotline” and the patient accepted for transfer to the HGH.

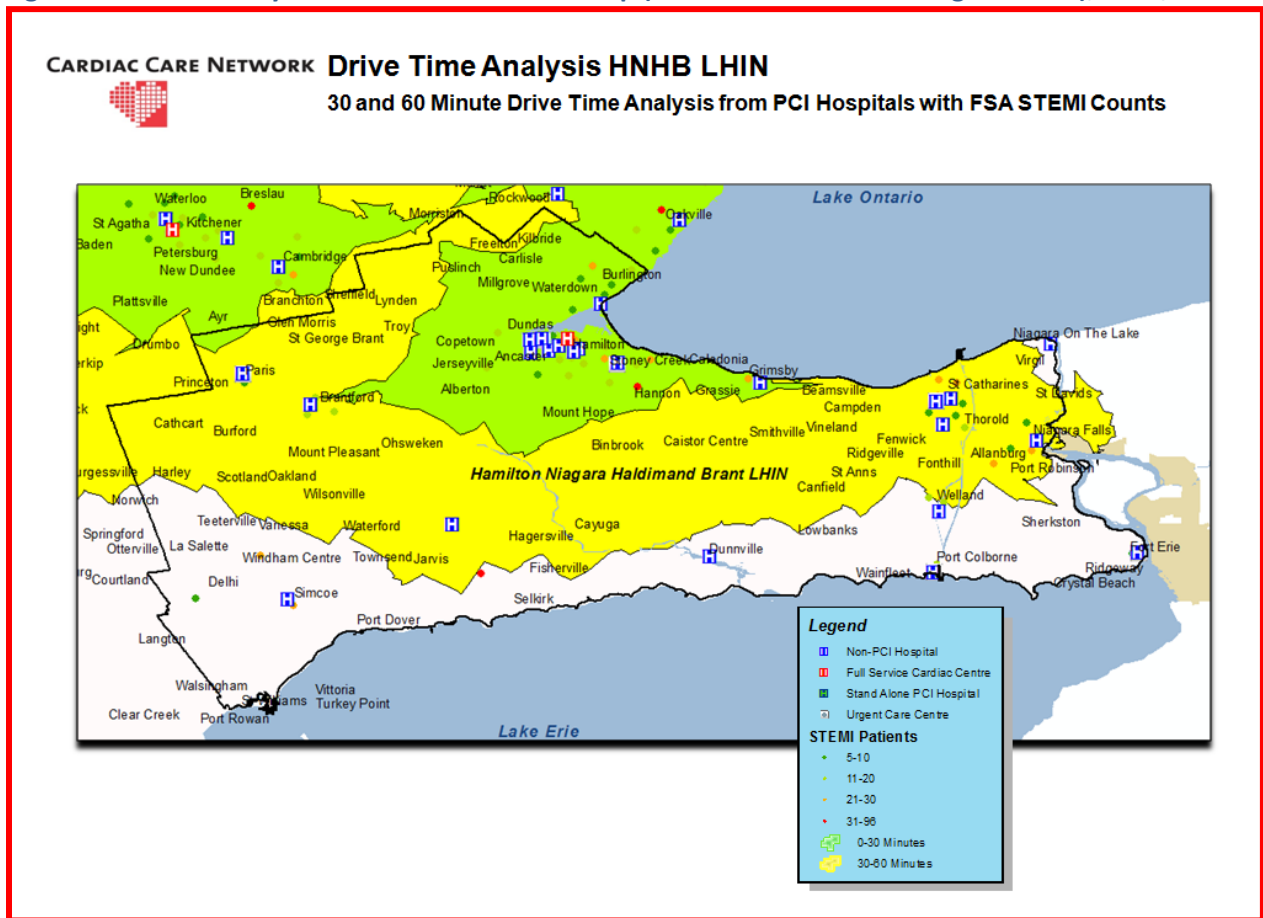
In 2010, the Primary PCI Initiative has evolved into the Strategic Management of Reperfusion and Therapies in Acute Myocardial Infarction (SMART-AMI). The SMART-AMI initiative is focusing on the development of an integrated strategy to deliver optimal medical care for all patients with STEMI in LHIN 4. This involves collaboration with Hamilton Health Sciences, regional hospitals, Emergency Medical Services, the LHIN 4 Cardiac Working Group and the LHIN 4 Emergency Services Steering Committee. Through improved communication, data collection, and a rapid feedback loop of key indicators, our goal is to enhance the uptake of evidence-based best practices in managing patients with STEMI in the region.

Highlights

- The program was implemented in January 2003, using a staged approach to offering primary PCI for STEMI patients within the region.
- The program services Burlington to Fort Erie and Burford to Cayuga and includes more than 1.3 million residents. Approximately 70% of the population resides in the Hamilton or Niagara areas.
- The program incorporates strategies for both patients who present by ambulance (including field-to-PCI centre transport when ECG acquisition is performed in the field) and by self-transportation.
- The program incorporates strategies for patients for whom primary PCI is not readily available, i.e., rescue PCI and pharmaco-invasive PCI post-fibrinolysis.



Figure D-4: Drive Analysis and STEMI Incidence Map (Hamilton Haldimand Niagara Brant), 2011/12



Source: CCN, using CIHI DAD, 2011/12



LHIN 6: Mississauga Halton

pPCI Program Service Level:

CARDIAC PROGRAM TYPE	SERVICE MODEL	■ = PROVIDED ■ = NOT PROVIDED	
Full Service PCI and Cardiac Surgery Program	■ Regional Transport	■ 24/7 Operations	■ EMS Triage Support

CCN Member Hospital: Trillium Health Centre

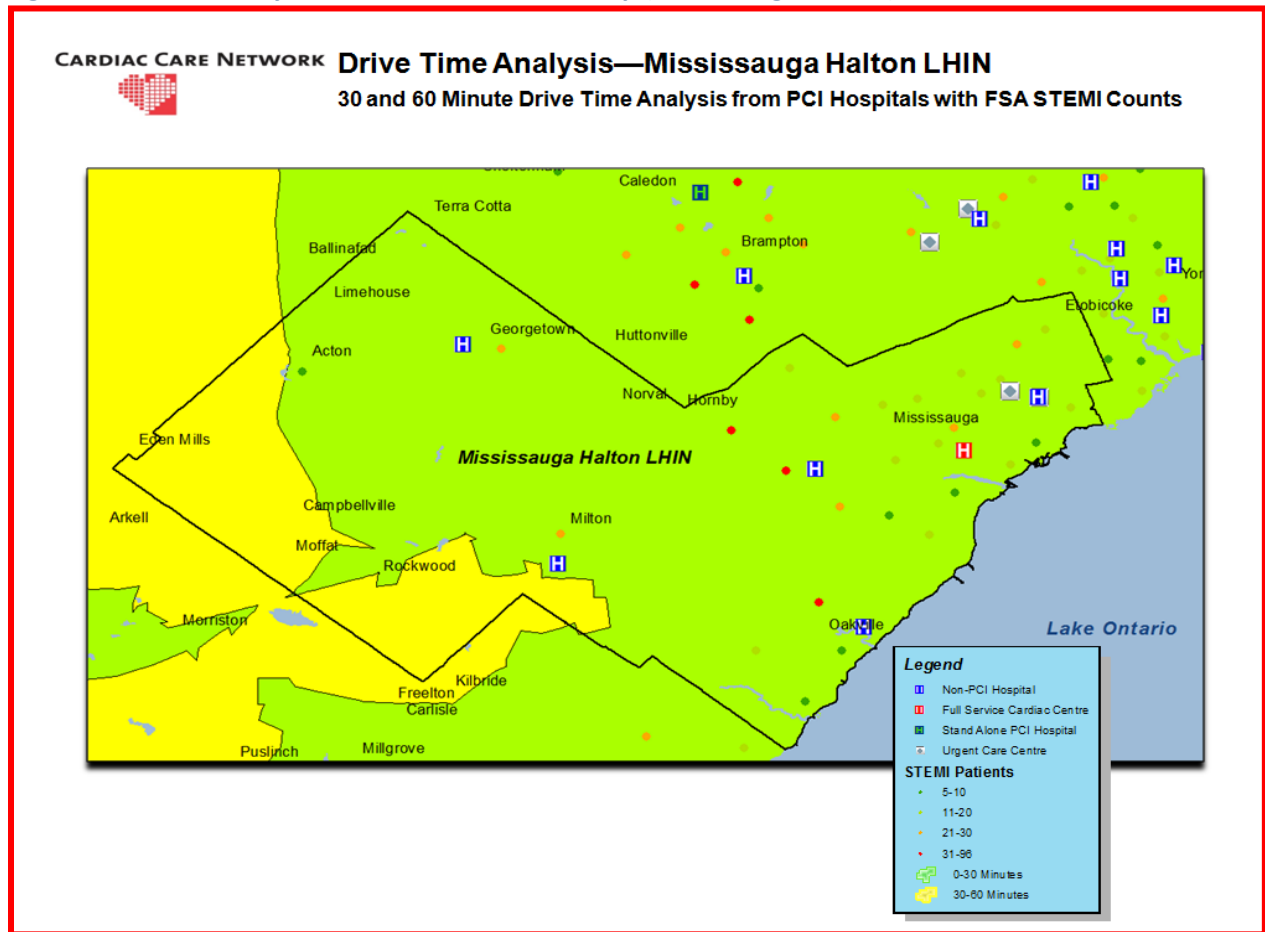
Program Overview

Trillium has been conducting primary PCI from its ED since 2005. Following a number of years of supported-for-rescue and facilitated primary PCI, in December 2008, Trillium launched the regional primary PCI Direct process with Halton Region EMS and the Sunnybrook Osler Centre for Pre-Hospital Care (SOCPC) with a 24 hour, 7 days a week ST Elevated Myocardial Infarction (STEMI) bypass protocol. The approach was developed in recognition of the complexity of the process and the fact that Trillium supports three EMS services that operate within our LHIN. Following the successful outcomes with Halton EMS, Trillium launched the process with Toronto EMS in May 2009, followed by Peel EMS in two phases (south Peel in August 2009 and north Peel in March 2010). Trillium’s data show our average time from door-to-first-device being 34 minutes, with the contact (EMS at patient) to first device is 74 min. Trillium’s performance has been sustained with the addition of each EMS service, which has increased our volumes and the travel distances. EMS has been able to sustain its time target of under 60 minutes from arrival to patient to arrival at Trillium 98 to 100% of the time.

Highlights

- The STEMI Direct program was implemented in 2008.
- Indirect STEMI program (STEMIs from non-PCI hospitals transferred to Trillium Cath Lab for primary PCI) introduced December 2010.
- The program serves over 1 million residents in the municipalities of South Etobicoke, Mississauga, Halton Hills, Oakville, and Milton, and covers approximately 900 square kilometers.
- As of the end of March 2010, STEMI Bypass for p PCI Direct has partnered Peel and Toronto EMS as well as Halton EMS. Our partnerships now include Halton Healthcare (Oakville, Milton, Georgetown sites) and William Osler Health Centre (Brampton Civic and Etobicoke General sites) as well as the catchment area of Trillium Mississauga and West Toronto sites.

Figure D-6: Drive Analysis and STEMI Incidence Map (Mississauga Halton), 2011/12



Source: CCN, using CIHI DAD, 2011/12

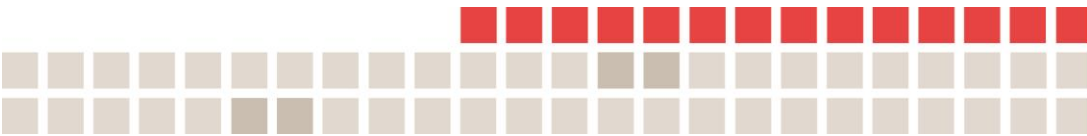
Heart program pays off for paramedics, patients

By Julie Slack

February 19, 2009 08:24 PM - A new program at Trillium Health Centre Mississauga that aims to provide heart attack patients with quicker access to life-saving care is already paying dividends for Halton residents — but Peel residents will have to wait several months.

Through the Cardiac Regional Direct PPCI (primary percutaneous coronary intervention) program, launched last Dec. 14, heart attack patients across the GTA will be brought by paramedics directly to Trillium's Hazel McCallion Centre for Heart Health, bypassing the emergency department at their local hospital.

The program is being introduced in phases, the first of which allows Halton Region paramedics — who, unlike their Peel counterparts, are already trained in using equipment in the field to determine heart attack status — to bring patients directly to Trillium's cardiac care facility.



When Peel paramedics have completed the necessary training, which is expected to take several months, they, too, will be able to rush patients directly to the Hazel McCallion Centre for Heart Health.

Until then, those suffering a heart attack in Mississauga will first be taken to the emergency department at either Credit Valley Hospital or Trillium Health Centre Mississauga, and then transferred, as required, to Trillium's cardiac care centre, where surgeons utilize a life-saving procedure that involves the insertion of a stent, or tube, into clogged arteries to help maintain blood circulation.

Once treated, the patient is moved back to their local hospital for further care.

Only paramedics with advanced care training can use the ECG (electro-cardiogram) to determine if a patient is having a heart attack. Once confirmed, they contact Trillium's on-call cardiologist directly and a team is immediately prepared for the patient's arrival.

Each region in the GTA is required to have a percentage of its paramedics trained in such care. John Hardiman, of Milton, was the first patient to benefit from the new program. Since then, 10 others have been treated.

On Dec. 21, Hardiman felt ill after waking up. His wife called Halton paramedics, who were on the scene in five minutes. The first responders quickly determined he would be taken directly to the cardiac care centre in Mississauga.

Once there, Hardiman underwent a 76-minute procedure to repair his heart. He was sent home four days later.

At a press conference held Wednesday at Trillium, Hardiman thanked members of the cardiac care team who saved his life.

Dr. Randy Watson, a cardiologist and Trillium's PPCI program director, said his team of doctors and nurses is on call around-the-clock. He said the new program is truly a life-saver.

"Time is everything," said Watson. "The heart is saved by this program. The minutes the heart is blocked cause irreversible damage. This is a terrific breakthrough."

Source: Trillium Health Centre,

http://www.trilliumhealthcentre.org/newsroom/trillium_in_the_news/documents/February_19_2009_Heart_program_pays_off_for_paramedics.pdf

LHIN 7: Toronto Central

CCN Member Hospital: University Health Network - Toronto General Site (TGH)

pPCI Program Service Level:

CARDIAC PROGRAM TYPE	SERVICE MODEL	■ = PROVIDED ■ = NOT PROVIDED	
Full Service PCI and Cardiac Surgery Program	■ Regional Transport	■ 24/7 Operations	■ EMS Triage Support

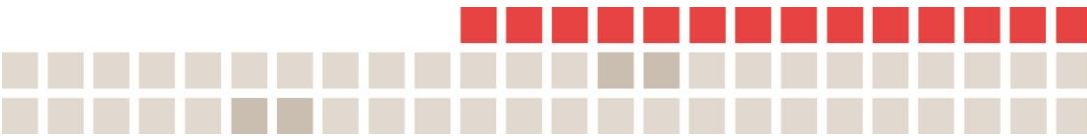
Program Overview

The University Health Network (UHN) is a member of the Toronto Heart Attack Collaborative (THAC). THAC is a partnership between the hospitals in the Toronto Central LHIN, EMS and the MOHLTC that provides timely treatment to patients experiencing a STEMI.

The Peter Munk Cardiac Centre at UHN provides a comprehensive 24-hour, 7 days a week approach to STEMI care where patients are brought directly to the cath lab at Toronto General Hospital (TGH) site for primary PCI. The STEMI team is activated by a call placed by a physician or EMS team member to an emergency number at the hospital's switchboard. This activates the STEMI pager system that sends a Code STEMI text message with the patient's location to the CICU team (who assess the patient) and cath lab team. Patients are taken directly to CICU and the cath lab for primary PCI. Immediately following primary PCI, the patient is transferred to a dedicated CICU STEMI bed for monitoring and nursing care. The Toronto Western (TWH) site also does primary PCI during the day Monday through Friday.

Highlights

- The TGH Code STEMI program was implemented in 2008.
- The program operates within Canada's most urban area with a population of 1.15 million people of diverse ethno-racial, social and religious backgrounds.
- The program is one of three centres in Toronto Central LHIN that provides 24-hour access to PCI.
- Level III paramedics are dispatched based on a citywide process called STAT (STEMI ALS Transport).
- The Toronto EMS diagnoses STEMI wherever they assess the patient and bypass the ED.
- In collaboration with Mount Sinai Hospital (MSH), STEMI patients are transferred through the underground tunnel joining MSH and TGH. The EMS transfers patients from the Toronto Western to the cath lab at TGH.



CCN Member Hospital: Toronto East General Hospital

pPCI Program Service Level:

CARDIAC PROGRAM TYPE	SERVICE MODEL	■ = PROVIDED ■ = NOT PROVIDED	
Cardiac Catheterization Program in partnership with SMH for PCI Program	■ Regional Transport	■ 24/7 Operations	■ EMS Triage Support

Program Overview

Toronto East General Hospital (TEGH) is a large community hospital in Toronto’s east end and historically, our ED has seen amongst the highest volumes of patients with acute coronary syndrome in the Greater Toronto Area. Our primary catchment area encompasses one of the most ethnically diverse areas of the province, many from lower socioeconomic backgrounds.

We have had a diagnostic cardiac catheterization laboratory since December 2001, with volumes of 1,800-2,000 cases per year, but our unit has not as yet gained approval to provide coronary interventional services.

TEGH has been a member of the Toronto Heart Attack Collaborative (THAC) since June, 2008 and our physicians and administration have played a central role at THAC in establishing an effective and sustainable model for collaboration between PCI centres and community hospitals in Toronto.

In support of the paradigmatic shift towards primary PCI for the management of patient with STEMI, we have developed a partnership with Toronto EMS and our colleagues at St. Michael’s Hospital (SMH) to ensure timely 24/7 access to primary PCI for Toronto East General patients.

Highlights

- TEGH’s Primary PCI partnership (Code STEMI program) became operational on April 1, 2009.
- In the first 18 months of operation, 128 Code STEMI patients have been transported to St. Michael’s Hospital.
- Of these, 88 patients (69%) have originated from the TEGH ED. This high percentage of EE transfers underscores the vital role played by ED nurses and physicians at TEGH in recognizing and expediting care.
- Median door to balloon times of close to 90 minutes for these ED transfers have been a testament to the effectiveness of the partnership and the excellent lines of communication and critical feedback between all involved.

CCN Member Hospital: Sunnybrook Health Sciences Centre

pPCI Program Service Level:

CARDIAC PROGRAM TYPE	SERVICE MODEL	■ = PROVIDED ■ = NOT PROVIDED	
Full Service PCI and Cardiac Surgery Program	■ Regional Transport	■ 24/7 Operations	■ EMS Triage Support

Program Overview

Sunnybrook Health Sciences Centre (SHSC) is a member of the Toronto Heart Attack Collaborative (THAC). THAC is a partnership between the hospitals in the Toronto Central LHIN, EMS and the MOHLTC that provides timely treatment to patients experiencing an ST elevation myocardial infarction (STEMI).

At SHSC, the hospital provides 24/7 STEMI care with EMS triage support. If a STEMI is confirmed, paramedics call SHSC's cardiac care unit using a dedicated STEMI hotline where information regarding the patient is relayed to a CCU nurse. A Code STEMI is immediately initiated which activates the cath lab team members (interventional cardiologists and nursing staff). When the patient arrives at SHSC, they are taken directly to the cath lab where an emergency angioplasty is performed. Following the angioplasty, the patient is transferred to a CCU bed at SHSC for monitoring and nursing care.

Highlights

- The SHSC Code STEMI program was implemented in 2008.
- The program operates within Canada's most urban area with a population of 1.15 million people of diverse ethno-racial, social and religious backgrounds.
- The program is one of three centres in Toronto Central LHIN that provides 24-hour access to PCI.
- Level III paramedics are dispatched based on a city-wide process called STAT (STEMI ALS Transport) and provide provisional diagnosis of MI using manual 12-lead ECG interpretations in addition to monitor interpretation.
- SHSC is the primary referral centre for STEMI patients at North York General and Humber River Regional Hospital.



CCN Member Hospital: St. Michael’s Hospital

CARDIAC PROGRAM TYPE	SERVICE MODEL	■ = PROVIDED ■ = NOT PROVIDED	
Full Service PCI and Cardiac Surgery Program	■ Regional Transport	■ 24/7 Operations	■ EMS Triage Support

Program Overview

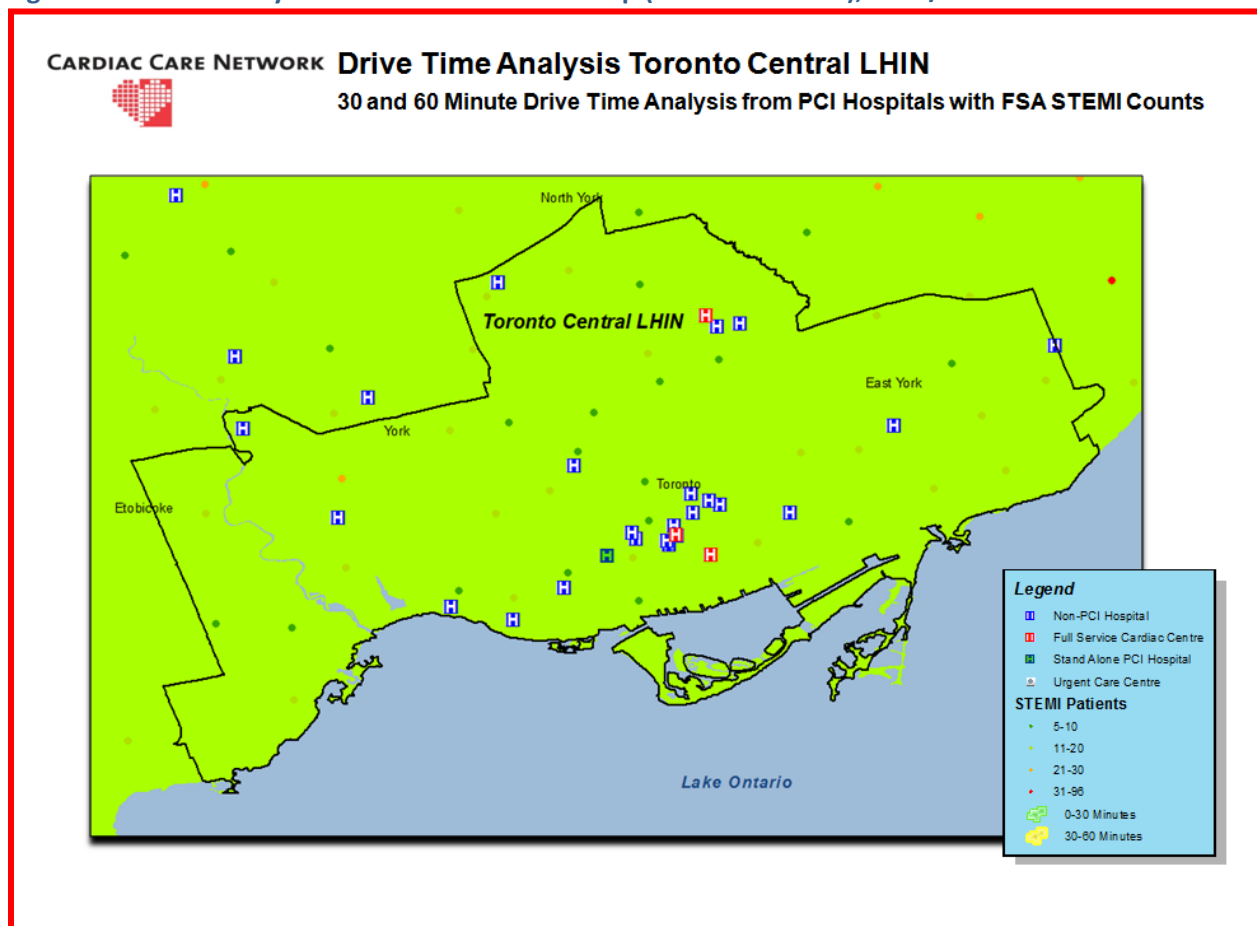
St. Michael’s Hospital is a member of the Toronto Heart Attack Collaborative (THAC). THAC is a partnership between the hospitals in the Toronto Central LHIN, EMS and the MOHLTC that provides timely treatment to patients experiencing STEMI.

St. Michael’s Hospital provides a comprehensive 24-hour, 7 days a week approach to STEMI care where patients are brought directly to the cath lab for primary PCI. St. Michael’s Hospital collaborates with Toronto East General Hospital and St. Joseph’s Health Centre to facilitate inter-hospital transfers of STEMI patients to St. Michael’s Hospital.

Highlights

- The St. Michael’s Hospital program was implemented in 2007.
- The program operates within Canada’s most urban area with a population of 1.15 million people of diverse ethno-racial, social and religious backgrounds.
- The program is one of three centres in Toronto Central LHIN that provide 24-hour access to PCI.
- Level III paramedics are dispatched based on a city-wide process called Code STEMI.
- The Toronto EMS diagnoses STEMI wherever they assess the patient, bypass the local ED and take the patient directly to the St. Michael’s Hospital cath lab.
- Patients from the St. Joseph and Toronto East General Hospital catchment areas are repatriated post primary PCI within six to eight hours for post-procedure recovery.

Figure D-7: Drive Analysis and STEMI Incidence Map (Toronto Central), 2011/12



Source: CCN, using CIHI DAD, 2011/12

St. Joseph's partners with St. Mike's for STEMI heart attack collaborative program

By Kris Scheuer

July 13, 2011

As the saying goes, time equals muscle when it comes to a heart attack. One way St. Joseph's Health Centre is enhancing the health of the communities we serve is by partnering with other providers so heart attack patients receive the right care, at the right time and in the right place.

A great example of this is the Toronto Heart Attack Collaborative that started in June 2008 and has helped patients in many ways including reducing length of stays in hospitals and decreasing the number of medications required. This collaborative program has paired St. Joseph's, Toronto EMS and St. Michael's Hospital so a patient with a ST elevation myocardial infarction (STEMI) receives access to timely care to prevent permanent heart damage.



This heart attack collaborative program worked for patient Terri Rohde. Early one morning in May, 2009 she was in the throes of a STEMI but wasn't sure it was a heart attack. The pain started in her shoulder but then increasingly radiated to her heart. Rohde, then 61, already had high blood pressure so she self-monitored and then searched the internet regarding her heart pain symptoms. The computer information urged her not to make her own way to a hospital emergency department, but instead to immediately call 9-1-1.

As part of this collaborative, high level Toronto EMS crew are trained to do an electrocardiogram and interpret the readings. EMS confirmed Rohde was having a STEMI and took her directly to St. Michael's, which has a catheterization lab so an interventional cardiologist could perform an emergency angioplasty and stent to unblock the occluded coronary artery. Rohde had originally called 9-1-1 around 2 a.m. and by 5 a.m. she was recovering from the angioplasty and a few hours later she was transferred to her community hospital St. Joseph's Cardiac Care Unit as an inpatient. Rohde recalls, "The faster you respond to a STEMI heart attack the less likely there is to be heart damage."

Dr. Mark Fisher, her St. Joseph's cardiologist explains, "The procedures are centralized and not every hospital has access to a catheterization laboratory. That's why we've partnered with St. Mike's, but everything else happens at St. Joe's." Currently, St. Joseph's sees about 100 STEMI patients annually. Our clinicians will adjust patients' medications, monitor their blood pressure, offer a smoking cessation program if needed, help them become ambulatory, educate them about heart health and get them safely ready to go home. In Rohde's case, she stayed at St. Joseph's for three days immediately after her STEMI.

Dr. Fisher said when he started at St. Joseph's 13 years ago, STEMI patients would stay in our hospital for a week to ten days. But inpatient stays are now shortened due to this collaborative effort that moves to definitive therapy and recovery sooner. Prior to July 2008, St. Joseph's STEMI patients were treated at our hospital with three anti-blood clotting medications to help open any occluded blood vessels. And a fourth thrombolytic drug was administered, but this last medication did not work for all patients and came with a risk of bleeding. If this course of action was not successful, STEMI patients would be transferred to a nearby hospital with a cath lab for an emergency rescue angioplasty and stent where a balloon was used to open up the blocked artery and a stent (metal mesh tube) was put in to prevent renarrowing.

Now when a patient with chest pains is brought to St. Joseph's emergency department, within moments of seeing a triage nurse an ECG is ordered to identify if the patient is having a STEMI heart attack, explains emergency physician Dr. Leeor Sommer. "So the moment they are triaged by our emergency nurses to the moment they have an ECG is in the order of about seven minutes, which is the fastest time in the GTA by far," said St. Joseph's Dr. Sommer. Patients will still receive the treatment of three anti-blood clotting drugs to get the process started but instead of adding a fourth drug as a solution that can present associated risks, STEMI patients are transferred to St. Michael's for an emergency angioplasty and stent.

"The sickest heart attack patients are getting the best care. The data shows this decreases mortality rates and their hearts are in better condition. So they are getting the best treatment," said Dr. Sommer. "Angioplasties have been regionalized so it's good to have someone assessed in a regional centre like St.



Michael's and then come back to us at St. Joseph's for more community-focused care."

While most heart attack patients are still men, more women are having them, testifies Rohde. She was already on a low-sodium, low-fat diet and monitoring her blood pressure, but the high-stress job she had at the time may have contributed to her heart attack, she said. In the end, the speedy care she received also helped with a complete recovery. Two years after her procedure and after care, she has no permanent heart damage.

Dr. Sommer added, "We want to provide the best care for the patients in our community. That's our biggest goal." He concluded, "I was part of the group that put together this Toronto Heart Attack Collaborative program together three years ago. It involved liaising with our emergency department, EMS, St. Joe's and St. Mike's cardiologists to ensure we could institute a program that was good for patients."

Source: St. Joseph's Health Centre Toronto,
http://www.stjoe.on.ca/about/publications/features_detail.php?id=5555



LHIN 8: Central

CCN Member Hospital: Southlake Regional Health Centre

pPCI Program Service Level:

CARDIAC PROGRAM TYPE	SERVICE MODEL	■ = PROVIDED ■ = NOT PROVIDED	
Full Service PCI and Cardiac Surgery Program	■ Regional Transport	■ 24/7 Operations	■ EMS Triage Support

Program Overview

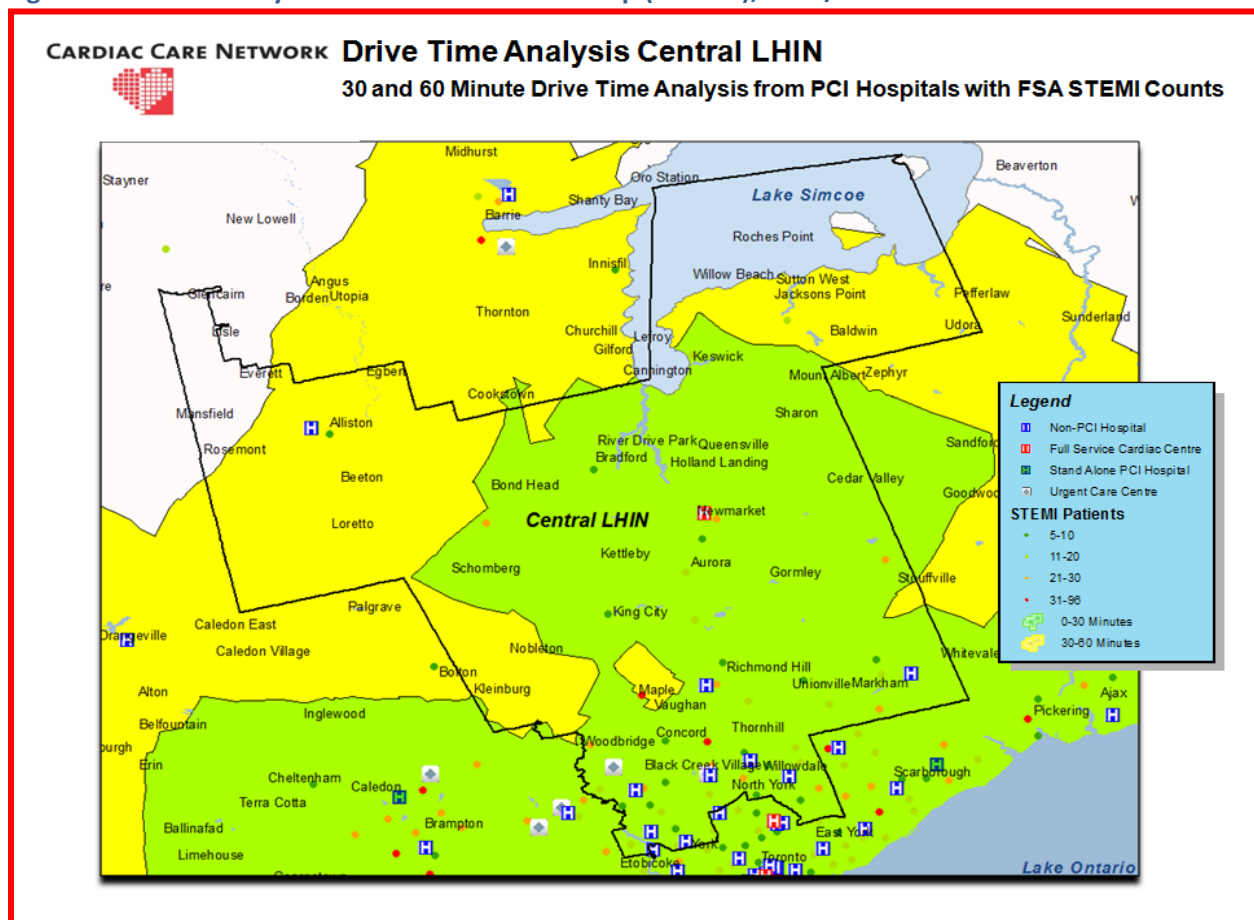
The program provides 24-hours, 7 days a week primary PCI for the region. All paramedics have been taught to perform and interpret 12-lead ECGs and diagnose STEMI using standard criteria. An EMS bypass system is employed, where patients diagnosed with a STEMI, with onset of symptom < 12 hours and within 45 minutes of SRHC, are brought directly to the cath lab for primary PCI. Code STEMI can be activated by EMS or the regional ED physician without the cardiologist’s approval. Cath lab and on-call interventional cardiologists are called to provide primary PCI. A reserved, guaranteed regional STEMI bed is always available. Repatriation agreements are in place with regional hospitals to return patients to their closest hospital post-PCI.

A joint program of Newmarket-based Southlake Regional Health Centre (SRHC) and York Region EMS employs technology that allows paramedics in York Region to wirelessly transmit an ECG – which they perform in the ambulance – to SRHC cardiologists. The physicians then review the ECG on a hospital computer screen or on their Personal Digital Assistant (PDA) to confirm the patient’s diagnosis and recommend the appropriate treatment, including authorizing paramedics to immediately administer intravenous clot-busting drugs (for STREAM study patients only).

Highlights

- The ED bypass for primary PCI program was implemented in January 2007.
- The program serves over 1.6 million residents that reside primarily in northern Toronto and the suburban communities north of the city located in the “905” and “705” areas, including the Highway 400 corridor.
- SRHC has successfully collaborated with the three paramedic services in the Region, offering primary PCI services to all patients meeting set criteria following a STEMI algorithm.
- SRHC and York Region are participating in an international study – the STREAM Trial – wherein patients who are more than 45 minutes from the hospital and who are given clot-busting medications in the ambulance are compared to those patients who undergo PCI within one hour of the diagnosis of a STEMI.

Figure D-8: Drive Analysis and STEMI Incidence Map (Central), 2011/12



Source: CCN, using CIHI DAD, 2011/12

Road-testing heart attacks

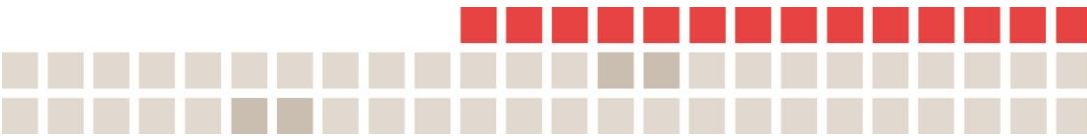
Toronto Star

November 7, 2007

An innovative program for treating heart attack patients has caught the attention of Toronto doctors who are hoping to adopt a similar program here.

For the first time, paramedics in Simcoe County can diagnose a heart attack in the ambulance and redirect the patient to Southlake Regional Health Centre in Newmarket, which can perform emergency angioplasties 24 hours a day. The proviso is that the ambulance must be within 45 minutes of Southlake.

The program was launched in February after a number of studies found "angioplasty was more effective than clot-busting drugs at saving lives, preventing repeat heart attacks, and preventing a stroke if done very rapidly," said Dr. Warren Cantor, an interventional cardiologist at Southlake and member of Cardiac Care Network of Ontario.



"We trained our paramedics on how to perform and interpret the ECG whenever they see a patient who has been having chest pains for several hours, and we also got the other (regional) hospitals involved, so they knew that their patients would be coming to us."

Heart attacks are triggered by a blockage of the arteries, preventing the flow of blood to the heart.

Only five other hospitals in the GTA – Sunnybrook, Toronto General, St. Michael's, Rouge Valley and Trillium in Mississauga – are able to perform an emergency angioplasty to reopen a blocked artery.

But that is only if a heart attack occurs before 5 p.m. A heart attack after hours can only be treated with the clot-busting drugs, which can be ineffective for a third of patients.

Despite the evidence angioplasty is a better treatment option, implementing the program is not so simple, says Dr. Eric Cohen, director of the Cardiac Catheterization Laboratory at Sunnybrook.

"We have some additional complexities in Toronto," he said. "There are issues of traffic, ambulance services and problems with the staffing of our hospitals, especially nursing staff."

Currently in Toronto, heart attack victims are not given an ECG by paramedics, and are usually taken to the nearest hospital, which may not have emergency angioplasty services. But training paramedics to diagnose heart attacks and acquiring technology for ambulances is already underway, said Cohen.

He doubts a Toronto program would involve after-hours cardiac teams at all hospitals; more likely is a rotation system among the five hospitals, or a regional division.

Or Toronto could follow the Edmonton model, where certain patients get clot-busting drugs if they show up early, while others go directly for an angioplasty, based on the paramedic's diagnosis en route.

Source: Toronto Star, November 7, 2007
<http://www.thestar.com/article/274312>

LHIN 9: Central East

CCN Member Hospital: Rouge Valley Health System

pPCI Program Service Level:

CARDIAC PROGRAM TYPE	SERVICE MODEL	■ = PROVIDED ■ = NOT PROVIDED	
Full Service PCI	■ Regional Transport	■ 24/7 Operations	■ EMS Triage Support

Program Overview

The Rouge Valley Health System (RVHS) Cardiac Care Program is a regional program in the Central East LHIN (CELHIN), one of the largest demographic LHINs in the province, serving Scarborough and Durham. Stand-alone PCI without on-site cardiac surgery was first trialed at RVHS in January 2003. Rouge Valley had a well-established cardiac catheterization laboratory prior to this.

In 2005, RVHS systematically introduced pPCI with a continued focus on improved patient clinical outcomes. RVHS completed a pilot Code STEMI project (within Scarborough only) from February 2009 to April 2010. Through CELHIN funding support, RVHS expanded the Code STEMI service to Scarborough and Durham as of April 27, 2010.

A multidisciplinary primary PCI collaborative committee meets regularly and includes both Toronto and Durham Region EMS, The Scarborough Hospital, Lakeridge Health Corporation and Rouge Valley Health System. Evidence-based protocols, algorithms, pre-printed order sets, policies, and door-to-balloon data collection tools were developed by the RVHS primary PCI committee, and continuous quality improvements made to maximize care delivery. Inter-hospital communication and support between EDs, MDs, nurses and EMS services are critical to the optimization of patient clinical outcomes. Critical care capacity, regional repatriation, staffing challenges, and patient awareness of cardiac infarct symptomology and the urgency of early reperfusion are important success factors. Despite some of the challenges of providing primary PCI 24/7, the RVHS primary PCI program continues to thrive and promote leading practices and to deliver gold-standard therapy for AMI. This is achieved by the dedication and cooperation of the RVHS cardiac team and its regional partners.

The collaboration with our partner hospitals and EMS was a critical success factor to ensure a consistent and standardized approach to the care of all cardiac patients in the CELHIN.

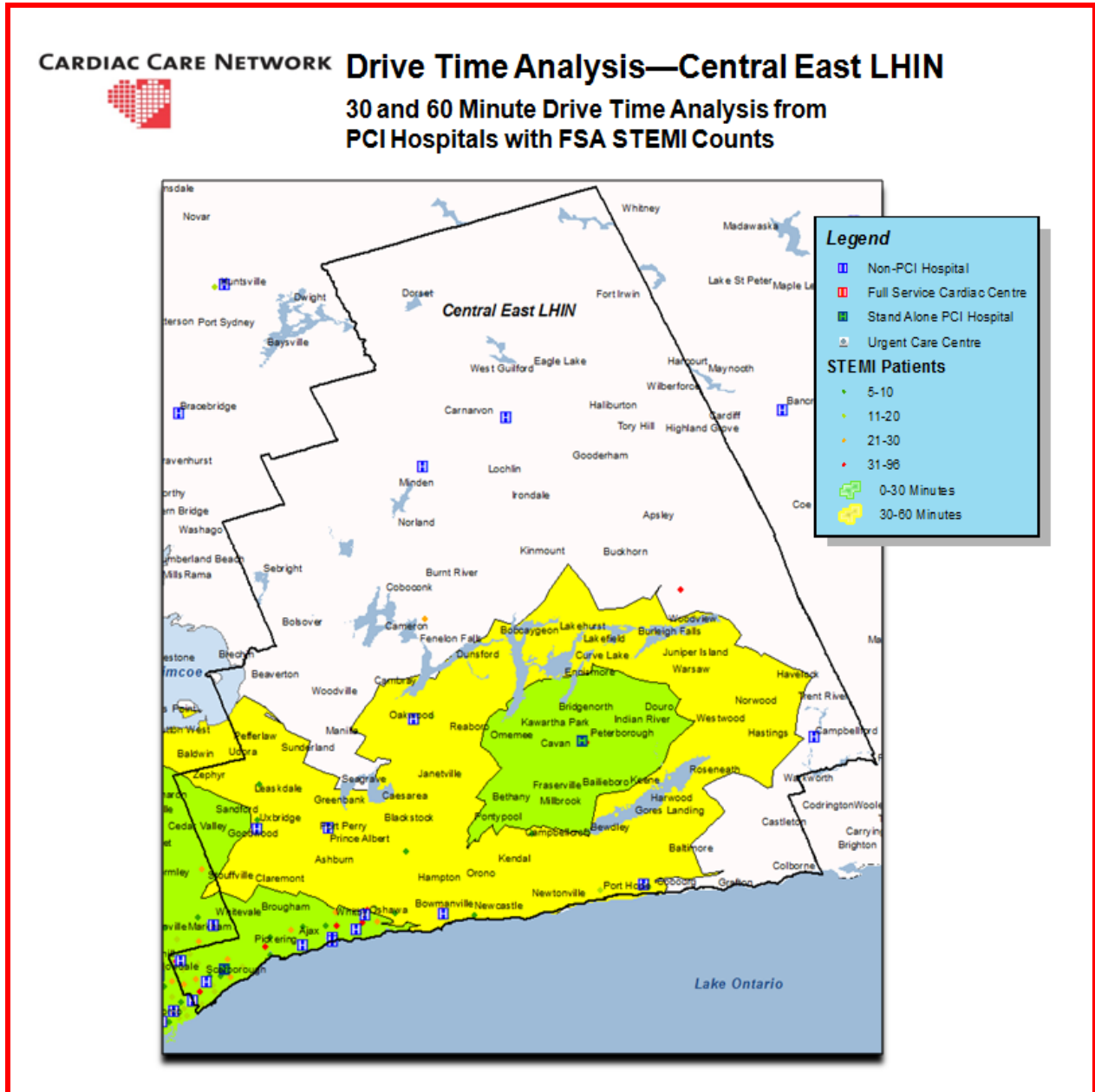
Highlights

- RVHS is a large community hospital within the CELHIN that services a population of 1.5 million people or 11 percent of Ontario's population. Almost half of its population resides in Scarborough; however, the CELHIN has a mix of rural, urban, and remote communities.
- We have a full service cardiac program including cardiac diagnostic testing, coronary intervention, advanced arrhythmia, inpatient coronary care, cardiac rehabilitation and secondary prevention.
- Rouge Valley was the first stand-alone PCI centre in Ontario to provide primary PCI .



- The Rouge Valley Cardiac Care Program currently has two catheterization labs, with strategic direction to expand to service the needs of the CELHIN, specifically East Toronto and West Durham.

Figure D-9: Drive Analysis and STEMI Incidence Map (Central East), 2011/12



Source: CCN, using CIHI DAD, 2011/12



Heart attack survivor credits Rouge Valley doctor, staff

By Tracey Fidler
Intern, Public Affairs and Community Relations

May 4, 2012

Fifty-four year old Whitby resident Angelo Joucas had barely been sick a day in his life. He exercised regularly, wasn't overweight and didn't have high cholesterol or diabetes. What he didn't know, was that his 40-year, two-pack a day smoking habit was about to catch up to him.

At about 11:30 p.m. on February 10, 2012, Angelo was getting ready for bed, when he suddenly began experiencing what he thought was a bout of indigestion. He drank six or seven glasses of water, trying to settle it down. Once in bed, he tossed and turned, unable to get comfortable. His chest felt heavy, he was having difficulty breathing and he began to sweat profusely.

Laurie, Angelo's wife, grew concerned, and called 911. Within minutes, Durham Emergency Medical Services (EMS) arrived and assessed his condition right at the scene, determining it was not indigestion, but in fact a heart attack. Angelo was given some baby aspirin, put on a stretcher and loaded into the ambulance to be taken to hospital, as his wife and two daughters looked on helplessly.

"My girls were balling their eyes out, and my wife was very upset," remembers Angelo. "But at no point was I afraid. I was just trying to reassure them that everything would be okay."

Once on their way, Angelo grew concerned when he noticed that the ambulance was driving in the opposite direction of the nearest hospital. What he didn't know then is that the extra half hour drive to Rouge Valley Centenary (RVC) saved his life. This hospital campus is the designated cardiac centre for the Central East Local Health Integration Network (CE LHIN), and has experienced staff with specialized training in cardiac care.

Upon arrival, Angelo was rushed straight to RVC's cardiac catheterization lab, where cardiologist Dr. Peter Gladstone and the cath lab team immediately tended to him. Angelo's left main coronary artery was blocked, obstructing most of the blood flow to his heart. Dr. Gladstone performed an emergency life-saving procedure, called a primary angioplasty. A catheter was inserted through the radial artery in his wrist, and a balloon was used to open the main artery to his heart. A stent was then deployed to keep the artery open. Because of the extent of damage, a balloon pump was then inserted to support the heart while it recovered.

"Heart attacks don't come any worse than this," explains Dr. Gladstone of Angelo's condition. "This was an unusual type, and it's universally fatal. He would have been dead within a few hours if he hadn't been transported to Centenary."

After the procedure, Angelo was sent to the coronary care unit (CCU), where he awoke several hours later. "It was like a very bad dream," he says. "They were telling me the next 18 hours were critical, but I felt fine. I guess I didn't realize how serious it really was."



Two days later, a second stent was placed in another artery that was also blocked. Thanks to the expertise of the staff and the less invasive nature of the procedure, Angelo was able to go home the next day, with a minimal recovery period. One month later he returned to the hospital for a check-up with Dr. Gladstone. An echocardiogram showed that Angelo's heart was almost back to normal. "He was quite amazed that I was doing so well," remembers Angelo.

Two months after his heart attack, Angelo is back at work and back to his regular routine: muscle cars, music, sports, and spending time with his family. He also quit smoking.

He has only positive things to say about his experience at Rouge Valley and Dr. Gladstone, in particular. "He's exceptional. I just can't say enough about him."

Dr. Gladstone credits a number of systems and procedures in place that helped save Angelo's life. He recognizes the in-field diagnosis by the EMS, which has only been in place in Durham Region for about 18 months. Secondly, he adds the fact the ambulance went directly to RVC, the regional cardiac care centre, gave Angelo access to the best care. He also credits the nurses, who are on-call 24 hours a day, and will come in on a moment's notice.

"It's a system success," he says. "This man is alive today because of the EMS, the hospital staff, and the life-saving procedures we do here."

Source: Rouge Valley Health System, <http://www.rougevalley.ca/hospital-stories/heart-attack-survivor-credits-rouge-valley-doctor-staff>

LHIN 10: South East

CCN Member Hospital: Kingston General Hospital

pPCI Program Service Level:

CARDIAC PROGRAM TYPE	SERVICE MODEL	■ = PROVIDED ■ = NOT PROVIDED	
Full Service PCI and Cardiac Surgery Program	■ Regional Transport	■ 24/7 Operations	■ EMS Triage Support

Program Overview

The STEMI (ST Elevated Myocardial Infarction) program represents a partnership between Frontenac County EMS and the Departments of Emergency Medicine and Cardiology at Kingston General Hospital (KGH). It provides emergent and urgent treatment for patients in the region who experience STEMI. Only KGH provides immediate access to angioplasty services between Ottawa, Peterborough and Oshawa.

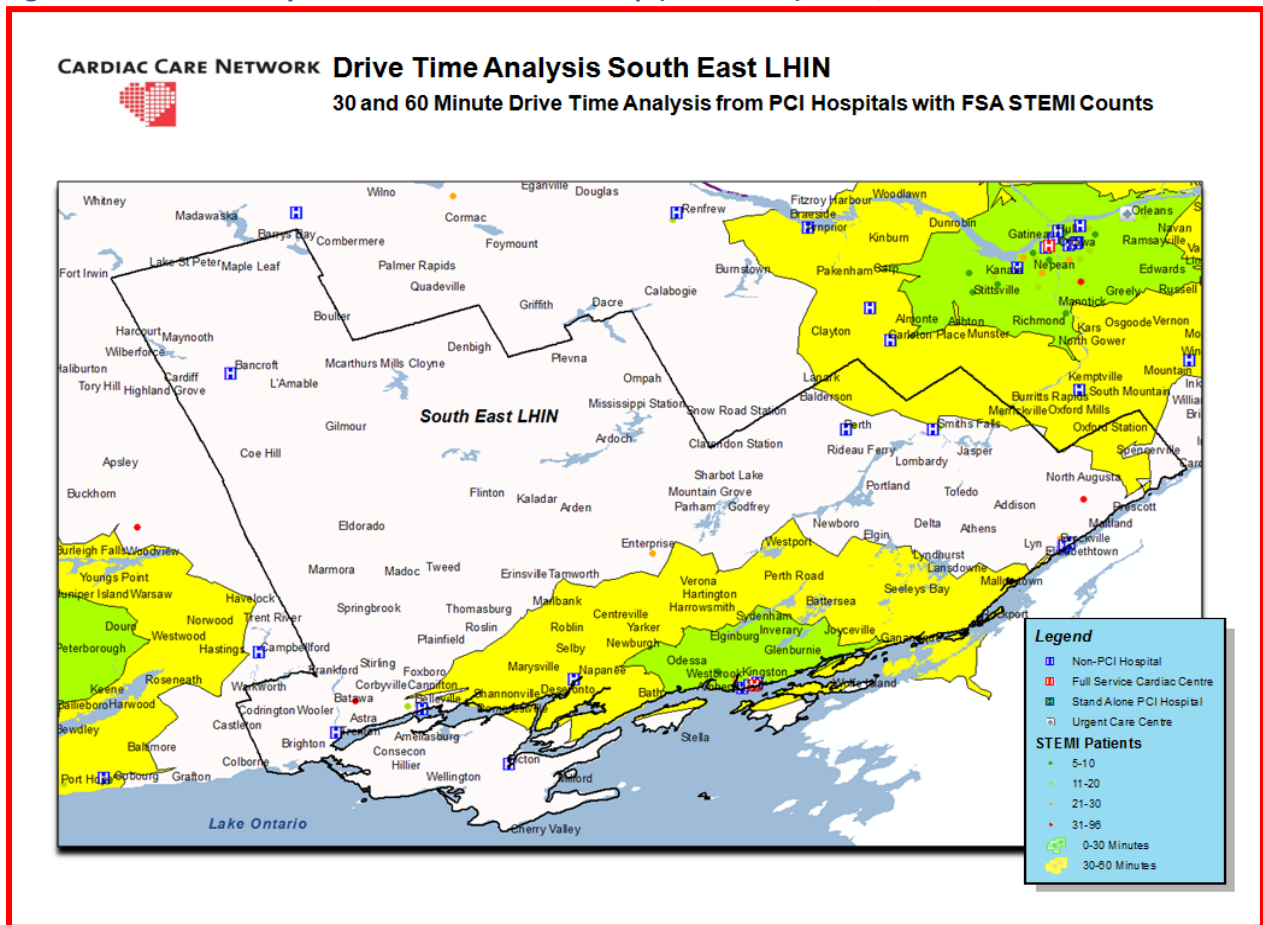
The STEMI initiative supports primary PCI treatment for patients from hospitals that can ensure transportation to KGH in less than 60 minutes to achieve a door-to-balloon time of 90 minutes or less. This affects patients within the immediate Kingston, Frontenac, Lennox and Addington area and including Napanee and Gananoque. Both basic and advanced care paramedics were taught how to interpret 12-lead ECGs and to diagnose a STEMI. Paramedics call ahead to the ED at KGH when transporting a STEMI patient to ensure the cardiac cath lab is ready for the patient before the patient arrives. Patients are taken directly to the cardiac cath lab at KGH.

Highlights

- The program was started in April 2005, and KGH was the first Ontario hospital to provide primary PCI 24 hours a day, 7 days a week.
- The program operates out of southeastern Ontario, home to close to 500,000 people across all of Hastings County, Lennox and Addington, Prince Edward County, Frontenac County, and the City of Kingston. It has a sizeable rural population with 44% of its residents living in communities of fewer than 10,000 people. One-quarter of the population resides in Kingston.
- Nearly 100 paramedics with the Frontenac Paramedic Services are trained to provide onsite electrocardiogram for patients with chest pain and anginal symptoms.



Figure D-10: Drive Analysis and STEMI Incidence Map (South East), 2011/12



Source: CCN, using CIHI DAD, 2011/12

LHIN 11: Champlain

CCN Member Hospital: University of Ottawa Heart Institute

pPCI Program Service Level:

CARDIAC PROGRAM TYPE	SERVICE MODEL	■ = PROVIDED ■ = NOT PROVIDED	
Full Service PCI and Cardiac Surgery Program	■ Regional Transport	■ 24/7 Operations	■ EMS Triage Support

Program Overview

Patients referred for primary PCI arrive either directly from the field or are referred from local emergency departments (EDs). The travel time for this pathway is less than 45 minutes to the University of Ottawa Heart Institute (UOHI). The program operates 24/7.

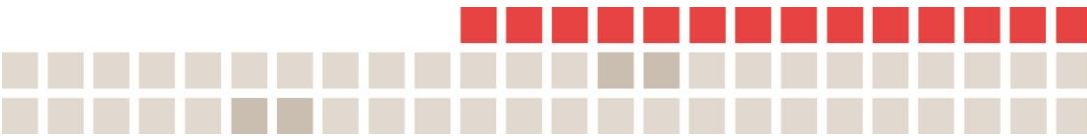
Paramedics in the City of Ottawa are equipped with the ability to perform pre-hospital electrocardiograms (ECGs). They have been trained to interpret the ECGs and independently triage patients with STEMI to the UOHI.

When a paramedic identifies a patient with STEMI in the field, they will call direct to the communication center (also known as “the bunker”) at the UOHI on a dedicated STEMI phone line to alert the transfer of a possible STEMI patient.

Paramedics are to inform the operator of the location of their departure (i.e., field), estimated time of arrival (ETA), and the status of the patient (e.g., cardiogenic shock, cardiac arrest). The operator will then initiate the “Code STEMI”, which will be announced overhead and activate a series of pager calls. Patients can also be transferred via ED referral. The ED physician identifies the STEMI by ECG and initiates the protocol for an urgent transfer to the UOHI for primary PCI. The ED will call dispatch for an ambulance, which will be sent as a Code STEMI status (Code 4 status ≠ Code STEMI). The activation of the PCI team via the Code STEMI protocol is by the paramedics, using the dedicated STEMI phone line. There are 9 local/ community hospitals that have been identified as primary PCI referring hospitals. These referring hospitals, which are listed below, are all located within a perimeter that allows timely referral to the UOHI for primary PCI:

- The Ottawa General Hospital
- The Ottawa Civic Hospital¹⁵
- The Montfort Hospital
- Queensway Carleton Hospital
- Almonte General Hospital
- Winchester District Memorial Hospital
- Arnprior District Memorial Hospital

¹⁵ The Ottawa Hospital- Civic Campus transfers patients through a connecting tunnel, not by ambulance. In this case, the Civic ED activates the Code STEMI.



- Carleton Place & District Memorial Hospital
- Kemptville District Hospital


When the communication centre operator is informed of an incoming STEMI, the operator activates the CODE STEMI protocol by an overhead announcement notifying all staff that there is an incoming STEMI patient and activation of pagers to nurse coordinator, cardiology resident, CCU STEMI nurse, catheterization laboratory and interventionalist. There is a specific **STEMI pager** assigned to the cardiology resident.

When the Code STEMI is activated, it is the responsibility of the cardiology resident to find out the patient's estimated time of arrival by calling the communication centre. The resident is expected to greet the patient immediately upon arrival and quickly review the data presented by the paramedic staff or ED staff, in particular the ECG. A targeted history and physical examination must be conducted, taking no more than 10 minutes.

When an Ottawa patient calls 911 complaining of chest pain, advanced care paramedics trained to interpret the results of an ECG and recognize ST elevation myocardial infarction are immediately dispatched. If a STEMI is confirmed, the patient is transported to the University of Ottawa Heart Institute where the STEMI cardiology team, on 24/7 standby, has been alerted to the pending arrival of the patient based on a Code STEMI protocol. On receiving the patient, the cardiology team is primed to perform an emergency PCI. The STEMI protocol, developed by the Heart Institute, represents an extraordinary collaboration between front-line health care workers, cardiologists, base hospital physicians and support staff. A collaborative alliance established among Ottawa's health care leaders enables advanced care paramedics to bypass conventional ED procedures and transport STEMI patients directly to the Heart Institute's STEMI lab. The alliance includes the four local Ottawa hospitals, 12 regional and community hospital sites, along with an immense base of emergency physicians, cardiologists and GPs, whose co-operation is essential. Because a suspected heart attack patient can also appear in the ED of another Ottawa hospital, the STEMI team relies on ED staff of that hospital to identify a STEMI and transfer the patient quickly to the Heart Institute.

Highlights

1. The UOHI was one of the first centers to report on the use of coronary stents for primary PCI: **Usefulness of intracoronary stenting in acute myocardial infarction. Am.J.Cardiol. 1996; 78:148-52.**
2. The UOHI conducted one of the first randomized trials which compared primary stenting with fibrinolysis therapy. **Stenting versus thrombolysis in acute myocardial infarction trial (STAT) J.Am.Coll.Cardiol 2001; 37:985-91.** The STAT trial was included in the now classic Keely's meta-analysis which showed primary PCI as the preferred strategy for reperfusion in STEMI because primary PCI reduces death, reinfarction and stroke. A cost analysis performed at the UOHI subsequently showed that primary stenting was better and cheaper than fibrinolysis therapy. This was an important step towards building a STEMI System in Ottawa.
3. The UOHI conducted the first Canadian randomized trial which assessed a pharmaco-invasive approach in a contemporary era: **Combined Angioplasty and Pharmacological Intervention Versus Thrombolytics Alone in Acute Myocardial Infarction (CAPITAL AMI Study) J Am Coll**



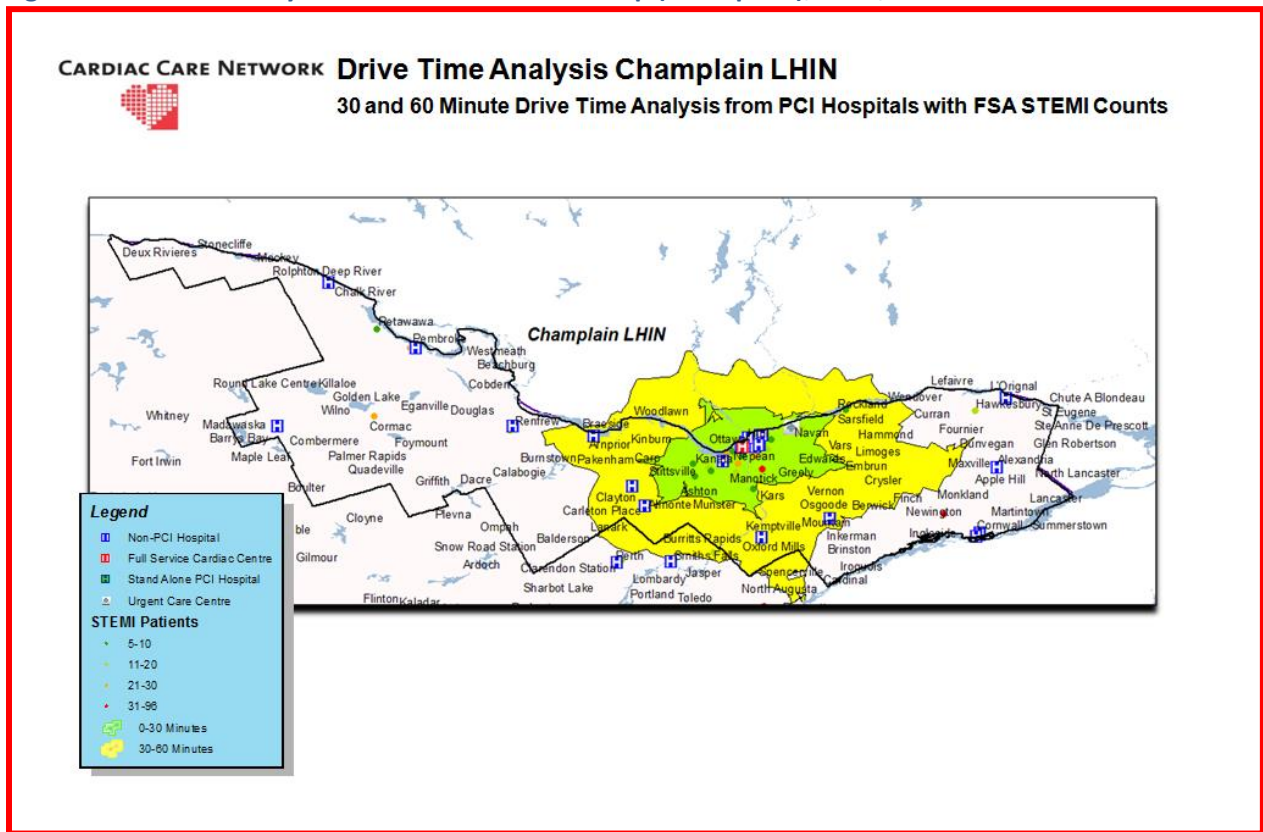
Cardiol. 2005; 46: 417-24. This trial was rated by the international community as one of top ten interventional trials published in 2005. The trial ushered the application of the pharmacoinvasive strategy and was also key to develop the STEMI system in Ottawa.

4. Two studies performed at the UOHI showed the benefit of paramedics in direct transport of STEMI patients to a PCI center and were additional building blocks for the STEMI program. The first study: **Diagnostic performance and potential clinical impact of advanced care paramedic interpretation of ST-segment elevation myocardial infarction in the field. Can J Emergency Medicine 2006; 8:401-40;** the second study: **Comparison of Early Mortality of Paramedic-Diagnosed ST-segment Elevation Myocardial Infarction with Immediate Transport to a Designated Primary Percutaneous Coronary Intervention Center to that of Similar Patients Transported to the Nearest Hospital. Am J Cardiol 2006; 98: 1329-1333.**
5. The UOHI demonstrated for a first time that a STEMI system could be designed and applied to an entire city and the results were published in the NEJM. It also highlighted the critical role played by the paramedics and the feasibility of implementing strategies needed to reduce door to balloon time. **A Citywide Protocol for Primary PCI in ST-Segment Elevation Myocardial Infarction. New England Journal of Medicine 2008; 358:231-240.**
6. The UOHI was first to show that STEMI system allowing EMS to transport patients directly to a primary PCI center is associated with a significant reduction in mortality. These results highlight the need for STEMI systems to include pre-hospital referral by EMS. **Reduction in Mortality as a Result of Direct Transport from the Field to a Receiving Center for Primary Percutaneous Coronary Intervention. J.Am.Coll.Cardiol 2012; 60 (14):1223–30.**

The UOHI is also a pioneer in the design of a **Code ROSC** (Return of Spontaneous Circulation) for managing patients who have been resuscitated from a cardiac arrest with therapeutic hypothermia. The UOHI Code ROSC program was presented at the Canadian Cardiology Conference held in Toronto 2012. The UOHI recently showed that therapeutic hypothermia can be combined with primary PCI. **The impact of therapeutic hypothermia as adjunctive therapy in a regional primary PCI program.** Resuscitation (2012), <http://dx.doi.org/10.1016/j.resuscitation.2012.08.002> Many of the STEMI patients are already benefiting from the application of this program in the Champlain LHIN.



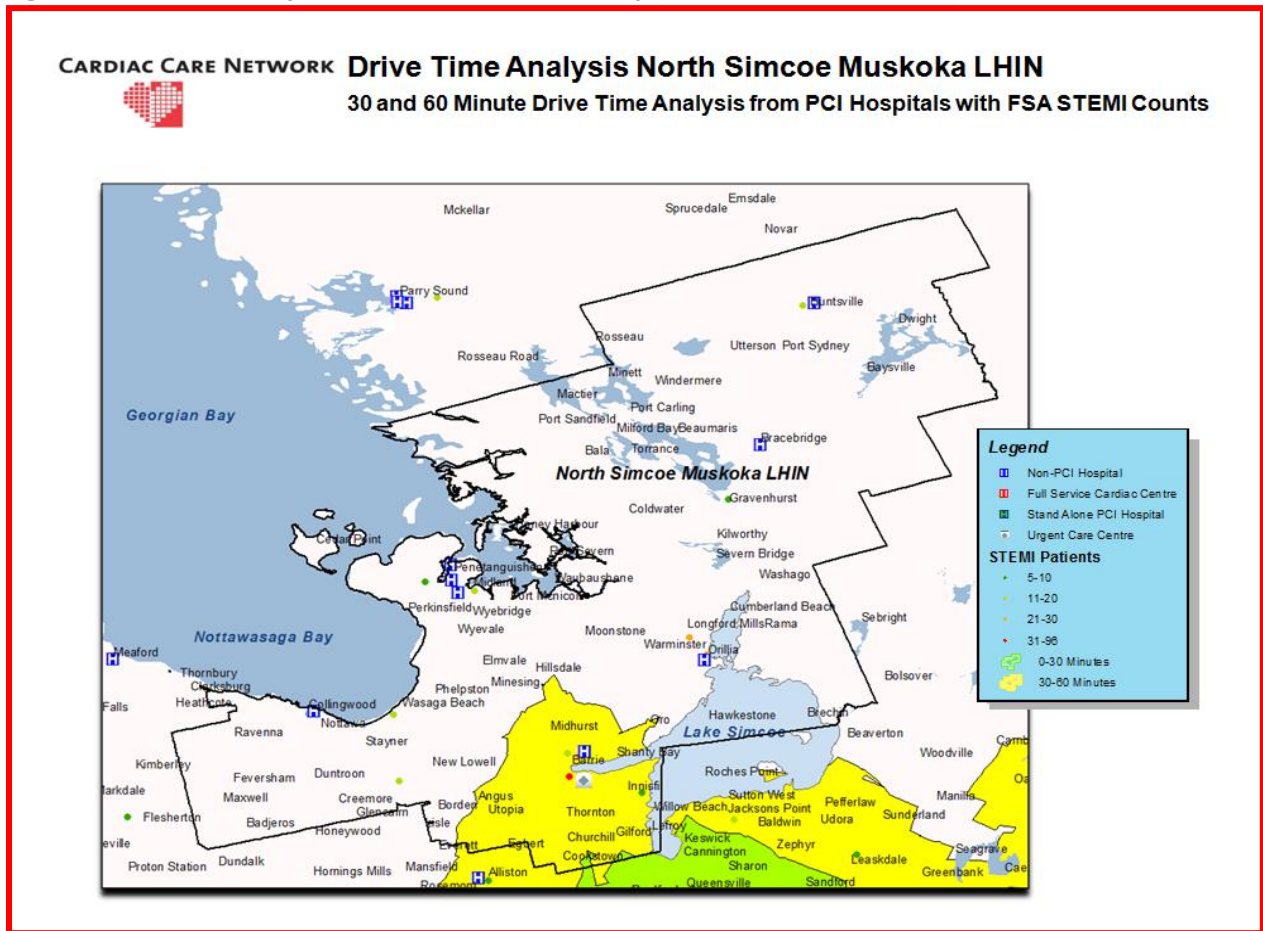
Figure D-11: Drive Analysis and STEMI Incidence Map (Champlain), 2011/12



Source: CCN, using CIHI DAD, 2011/12

LHIN 12: North Simcoe Muskoka

Figure D-12: Drive Analysis and STEMI Incidence Map (North Simcoe Muskoka), 2011/12



Source: CCN, using CIHI DAD, 2011/12



LHIN 13: North East

CCN Member Hospital: Health Sciences North

CARDIAC PROGRAM TYPE	SERVICE MODEL	■ = PROVIDED ■ = NOT PROVIDED	
Full Service PCI and Cardiac Surgery Program	■ Regional Transport	■ 24/7 Operations	■ EMS Triage Support

Program Overview

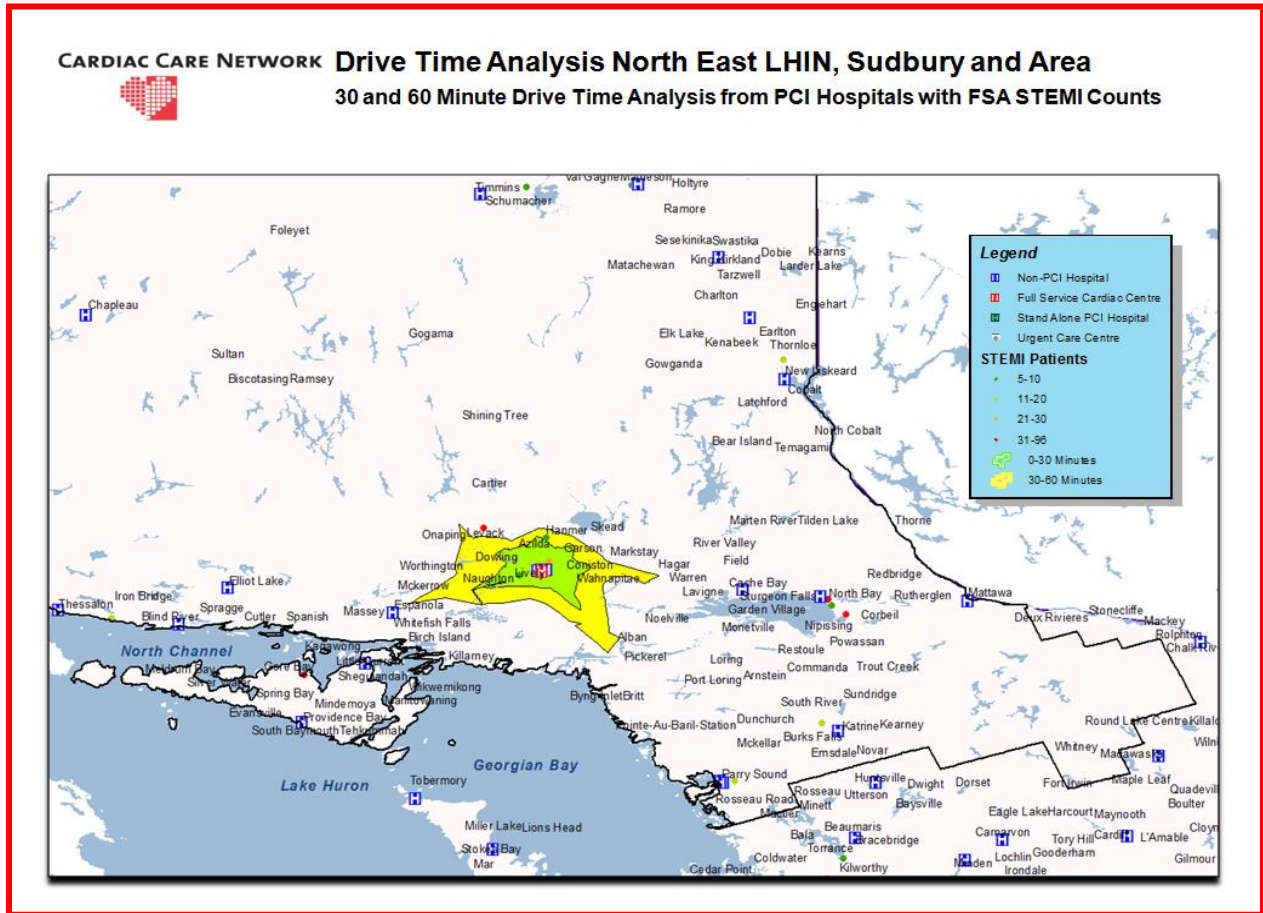
The Sudbury Regional Hospital boasts a primary PCI program. Once a diagnosis of ST elevation MI (STEMI) has been established, the patient is promptly transferred to the cardiac cath lab for primary PCI. This service is available to all residents who present to the ED shortly after onset of chest pain and are then diagnosed with an evolving STEMI. Because of the geographical challenges of the North East LHIN, it is not possible to offer primary PCI to residents who may be hours away. It is, therefore, prudent to treat these patients with thrombolysis and then transfer them to our tertiary centre for rescue PCI if warranted.

Primary PCI service is available 24/7 with cardiologists and interventional cardiologists on call at all times.

Highlights

- The program supports communities in northeastern Ontario, home to a population of 567,900 people, or 4.6% of the population of Ontario. Just over 28% of the North East area is highly concentrated in Greater Sudbury with Sault Ste. Marie and North Bay the next most populous areas.
- HSN has recently added a TAVI and ICD implantation program.
- As of April 2010, the Greater Sudbury Emergency Services, Sudbury Regional Hospital, Northeastern Ontario Pre-hospital Care Program and the MOHLTC CACC have collaborated to develop a STEMI Bypass/Alert process by which patients presenting in the pre-hospital environment with STEMI can be transported by paramedics directly to the cath lab. This program currently runs Monday to Friday during 0700–1700 hours. After-hours patients are seen in the ED first.

Figure D-13a: Drive Analysis and STEMI Incidence Map (North East, Sudbury and Area), 2011/12



Source: CCN, using CIHI DAD, 2011/12

LHIN 14: North West

CCN Member Hospital: Thunder Bay Regional Health Sciences Centre

CARDIAC PROGRAM TYPE	SERVICE MODEL	■ = PROVIDED	■ = NOT PROVIDED
Cardiac Catheterization and PCI Program	■ Regional Transport	■ 24/7 Operations	■ EMS Triage Support

Program Overview

Thunder Bay Regional Health Sciences Centre (TBRHSC) offers a stand-alone PCI program (no cardiac surgery on site) to the northwest region of Ontario including the district of Kenora, Rainy River and Thunder Bay, incorporating significant distances of approximately 1,000 km.

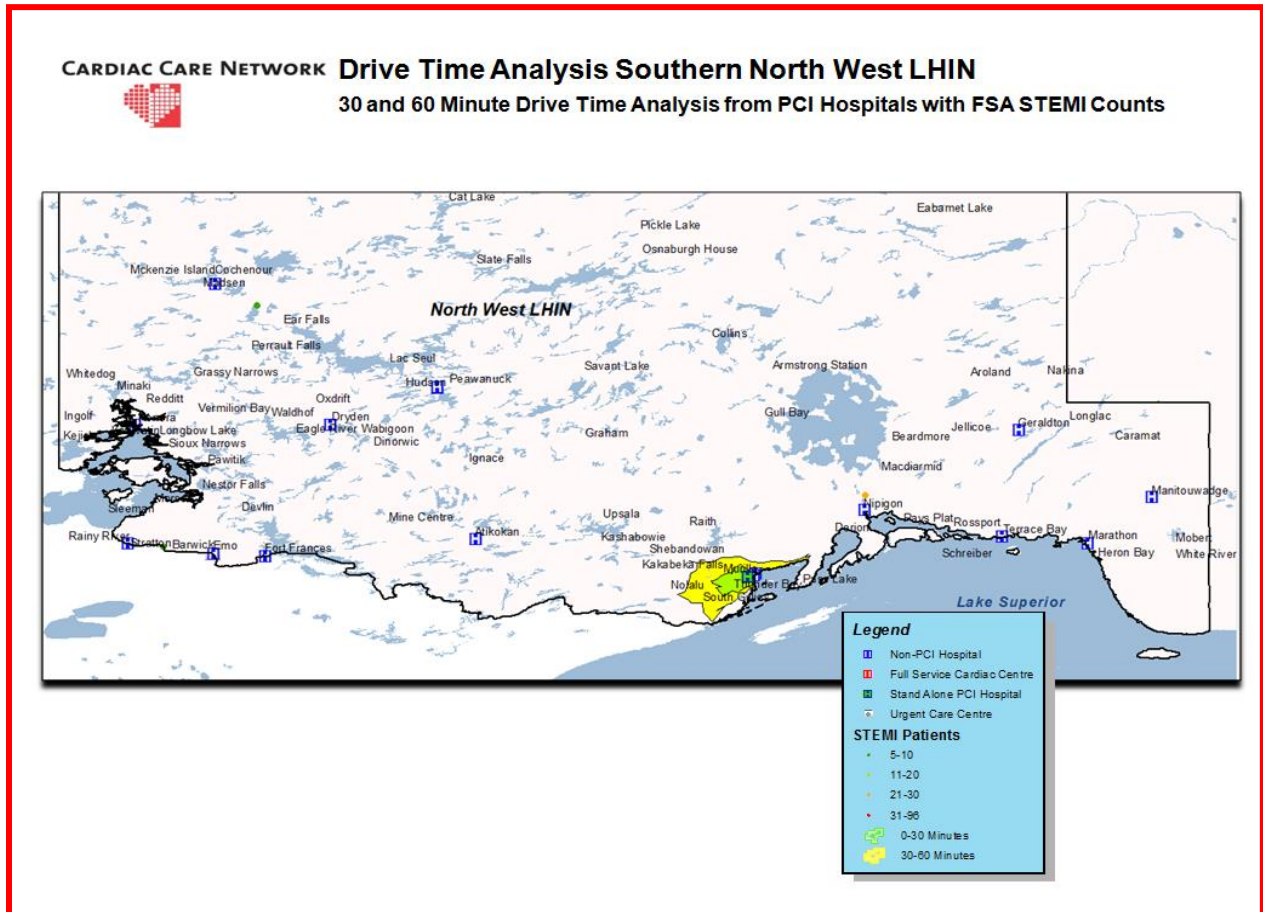
Since an expansion of its services in October 2011, TBRHSC has offered 24/7/365 primary PCI for STEMI patients; EMS and community hospitals are an integral part of a pharmaco-invasive approach of administration of lytics and direct transport for STEMI patients at distances greater than 90 minutes away from TBRHSC.

Highlights

- Stand-alone angioplasty program established October 2007 through the mentorship of the University of Ottawa Heart Institute. A partnership developed with St. Luke's Hospital, Duluth Minnesota, provides cardiac surgery as back-up for the program.
- TBRHSC serves a vast Northwestern Ontario region of isolated communities, including 30% First Nations communities.
- Significant financial burden due to travel costs is lessened through the on-site cardiac intervention program at TBRHSC.
- TBRHSC supports the Northern Ontario Medical School that was initiated in 2005.

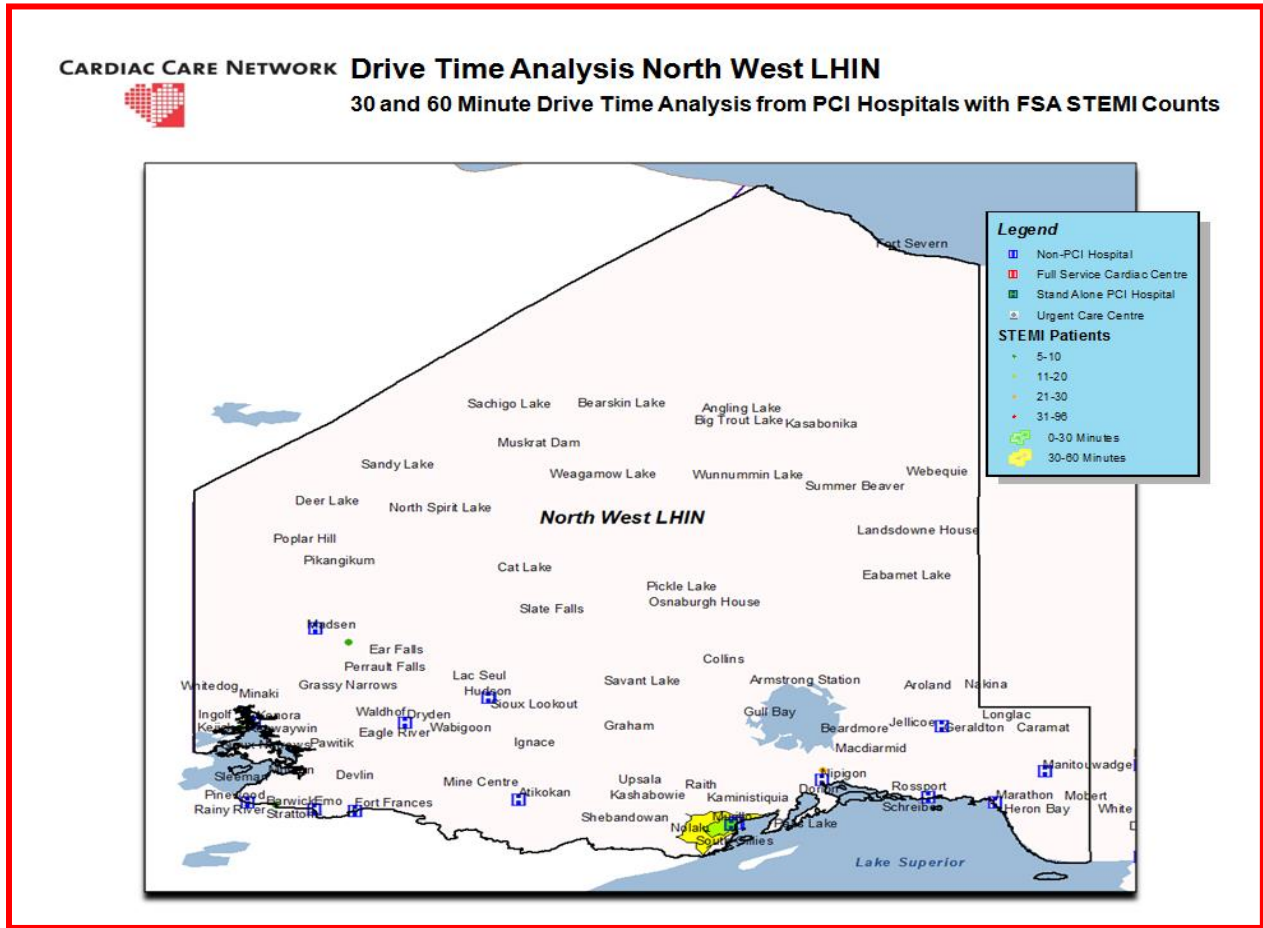


Figure D-14a: Drive Analysis and STEMI Incidence Map (North West (Southern)), 2011/12

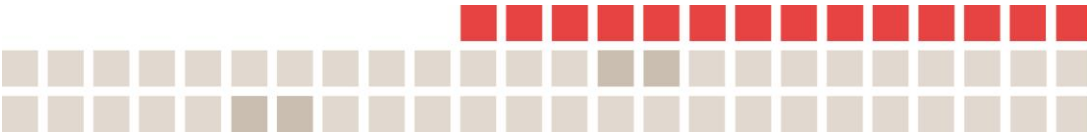


Source: CCN, using CIHI DAD, 2011/12

Figure D-14b: Drive Analysis and STEMI Incidence Map (North West), 2011/12



Source: CCN, using CIHI DAD, 2011/12



Appendix H: Draft Patient Information Requirements

When a patient who has been diagnosed or suspected of having a STEMI, the following standard information should be provided to the accepting physician (whether in the ED or the cath lab):

- Time of first medical contact.
- Results of all 12-lead ECGs conducted in the ambulance.
- Medications that have been administered and when they were administered.
- Whether the patient has been intubated or defibrillated.
- Whether the patient was unconscious and for how long.
- Whether the patient had CPR.
- What other intensive care has been provided or other treatments initiated (if any).

Appendix I: AHSC AFP Innovation Fund Report Excerpt– Highlights of Data Issues

This appendix is an excerpt from an Academic Health Sciences Centre Alternative Funding Plan (AHSC AFP) Innovation Fund entitled: SMART AMI: Strategic Management of Acute Reperfusion and Therapies in Acute Myocardial Infarction. An Evidence-Based LHIN-wide Approach to ST Elevation Myocardial Infarction (STEMI) Care.

C. Table of Evaluation Metrics:

METRIC	STATUS	COMMENT	FINDINGS
STEMI REPORTING	STEMI reporting ongoing for cases diagnosis with STEMI	Standardized STEMI management protocol for LHIN-4 has facilitated identification and management of STEMI	Chart audit and comparison with CIHI data suggests that some degree of "under-reporting" may be happening either due to "non-reporting" or "misclassification of STEMI" as other types of MI or missed MI
REPERFUSION	93.6% of reported STEMI treated with PPCI or fibrinolysis	Evidence suggests that in areas of Europe with regional networks the optimal reperfusion rate is between 88-90%	Some patients are not eligible for reperfusion due to contraindications for PPCI or fibrinolysis or alternative diagnosis after initial presentation. However, some patients do not receive reperfusion due to delayed presentation (eg > 12hours after symptom onset) or delayed or missed diagnosis.
PPCI	79% of reported STEMI	PPCI is preferred reperfusion modality when available in a timely manner	Availability of pre-hospital diagnosis and bypass to PCI site with 2 EMS services in region has increased proportion of patients eligible for PPCI in timely manner. PPCI could be offered to more patients if all 7 regional EMS services have access to equipment and training of ECG acquisition and memorandum of understanding between PPCI site and EMS service for pre-hospital bypass.
Cardiac Catheterization and PCI Post Fibrinolysis	80% of patients initially reperfused with fibrinolysis have urgent PCI within 24 hrs	Evidence suggests that active processes of post fibrinolysis identification and referral for Rescue PCI (ie patients who fail reperfusion with fibrinolysis) or Pharmacoinvasive PCI (ie patients who have successful reperfusion with fibrinolysis but are high risk) improves patient outcomes	Prior to SMART AMI there was variability in both identification and management of patients post-fibrinolysis.
NORMAL CATH	3% of patients referred for primary PCI	Evidence suggests that a normal cath rate of less than 10% is an indicator of an efficient Primary PCI program.	Avoidable Activation of the cath lab and False Positive STEMI identification are important for both patient safety (ie avoidance of unnecessary procedures that may

macintosh hd:users:madhunatarajan:dropbox:briefcase:final report to hahso:smart ami natarajan welsford final report for afp hahso.doc



			cause harm), efficiency (ie avoiding cancellation or postponement of other booked procedures) and costs (ie appropriate use of limited human and physical resources). Availability of a network and continuous audit and feedback through SMART AMI processes facilitates these efforts.
ASA and Clopidogrel	>90% of eligible patients	Evidence suggests that early administration of dual antiplatelet therapy in eligible patients reduces death and recurrent myocardial infarction.	A standardized protocol in every ED across the LHIN facilitated this benchmark. Having a regional framework will also facilitate implementation of new anti-platelet agents (eg ticagrelor) as they become available. In future, medical directives from Base Hospital may also facilitate administration of evidence based antiplatelet therapy in the ambulance at the time of pre-hospital ECG acquisition and diagnosis.
DISCHARGE MEDS	80-90% of eligible patients received aspirin, clopidogrel or similar, beta-blocker, ACE inhibitor or ARB and a statin at hospital discharge	Evidence suggests that the greater the proportion of patients discharged on these five classes of medications after a heart attack, the better the patients outcomes.	There was a rapid attrition in the proportion of patients still taking these evidence based therapies at 90 days documented by telephone based follow-up. Further initiatives in ensuring compliance to secondary prevention with medications as well as smoking cessation and referral for cardiac rehabilitation programs are urgently needed. These data are also consistent with our finding that although greater than 80% of patients had at least one risk factor for heart-attack prior to their STEMI presentation, only a small proportion were being treated with evidence-based therapies prior to presentation.
EARLY DISCHARGE	Overall length of stay was a median of 4 days; 50% of all patients were eligible for early discharge as per protocol; 68.5% of patients eligible for early discharge attended bridging clinic	Avoidable days in hospital length of stay will improve efficiencies and costs to the health care system. Evidence suggests that a significant proportion of STEMI patients may be safely discharged early based on STEMI risk scores (eg Zwolle) and admission is uncomplicated. This needs to be	Our data were consistent with the reported literature in the proportion of patients eligible for early discharge. Approximately 70% of patients were able to have bridging contact. Our patient surveys indicated that many patients preferred a telephone follow-up rather than a clinic visit due to difficulties in travel. There may be a role in future for structured follow-up using telemedicine technologies. In addition, in a small pilot initiative we found that utilization of a structured "checklist" to perform the contact visit

macintosh hd:users:madhunatarajan.dropbox:briefcase:final report to hahso:smart ami natarajan welsford final report for afp hahso.doc

		complemented by early “bridging” contact avoid unnecessary hospital visits or admission and follow-up with family physicians and specialist care.	or phone call was feasible and more efficient.
EMS vs SELF	40% of patients with STEMI arrived to hospital by self-transport. This remained constant throughout the observation period.	Evidence suggests that using EMS plays an important role in minimizing delays to diagnosis and treatment of STEMI. In addition, recognition of STEMI in the pre-hospital phase may allow for redirect to a PPCI centre in a timely manner and administration of potentially life-saving therapies (ie defibrillation, aspirin, fibrinolytic therapies) in the ambulance.	The problem of self-presentation is universal and has important effects on timely access to heart attack care. In our observation period the median treatment time for EMS presenters was 75 minutes and for self-presenters was 111 minutes. Because the proportion of self-presenters is significant, regional STEMI networks need to recognize this issue and implement strategies aimed at improving the triage processes in ED such that such STEMI patients are identified and treated in a timely manner. Future research should focus on improving our understanding of why patients do not use EMS so that education strategies for promoting EMS use may be more effective.
Median D2B < 90 for PPCI presenting at PCI site Median D2B < 120 for PPCI transferred in from nonPCI site Median D2N < 30 minutes (for fibrinolysis)	Median - 75 min IQR – 55-95 min Median - 111 min IQR - 95-142 min Median – 31 min IQR 16-53 min	Evidence suggests that time to reperfusion with either PPCI or fibrinolysis is associated with recovery of heart function and mortality. The AHA recommends that median door to balloon for patients presenting to a PCI centre should be <90 minutes, patients initially presenting to a non-PCI centre and then being transferred should be <120 minutes and door to needle time for fibrinolysis should be <30 minutes.	The regional network established by the SMART AMI initiative was successful in achieving these international benchmarks. Further improvement in treatment times can be achieved by addressing some of issues discussed earlier in this tables including: a) equipping and enabling all EMS providers to obtain pre-hospital ECG in the ambulance in patients with suspected STEMI and establishing directives for pre-hospital bypass to a PPCI centre where timelines are feasible or early notification of local hospital for prompt fibrinolysis; b) further improving efficiency of diagnosis and triage in patients presenting by self transport to the ED; and c) further understanding of reasons and providing public education to reduce the proportion of patients not taking EMS in the setting of acute chest pain.

macintosh hd:users:madhunatarajan.dropbox:briefcase:final report to hahso:smart ami natarajan welsford final report for afp hahso.doc



Glossary of Terms

12-lead ECG	A diagnostic procedure in which 12 leads are attached to patient's arms, legs and chest wall to record the electrical activity (rhythm) of the heart.
Advanced Cardiac Life Support (ACLS)	A specialty (certification) in advanced life support measures usually retested bi-annually.
ALS Paramedic	Advanced Life Support Paramedic. This level of paramedic has received advanced training in emergency medical service delivery.
AMEMSO	Association of Municipal Emergency Medical Services of Ontario (now the Ontario Association of Paramedic Chiefs).
Angina	Chest pain caused by lack of oxygen (blood flow) to the heart.
Regional Base Hospital	A Regional Base Hospital provides medical direction, leadership and advice in the provision of ambulance based pre-hospital emergency health care within a broad based, multi-disciplinary, community emergency health services system in a specified geographical area. In addition, the Regional Base Hospital provides training, quality assurance, continuing education and guidance to ambulance based pre-hospital emergency care providers.
BCLS	A certification in basic life support.
Canadian Institute for Health Information (CIHI)	Mandate was established jointly by federal and provincial/territorial ministers of health – to coordinate the development and maintenance of a comprehensive and integrated approach to health information for Canada, and to provide and coordinate the provision of accurate and timely data and information.
Cardiac catheterization	A diagnostic procedure in which a catheter is introduced into the coronary artery to determine blockage. This is also referred to as coronary artery angiogram.
Cardiovascular disease (CVD)	Diseases affecting the heart and major blood vessels.
CABG (Coronary artery bypass graft)	Heart surgery in which a procedure is done to bypass a narrowing or blockage in a coronary artery. This surgical procedure is used to restore blood flow around previously blocked arteries.
Coronary Care Unit (CCU)	A specialized unit that provides intensive care to patients suffering from coronary/cardiac diseases.
Door in-Door out (DIDO)	Time from arrival at ED to departure from ED.
Door-to-balloon (D2B)	The elapsed time from when the patient arrives at the hospital until the first balloon is inflated for primary PCI.
Door-to-needle (D2N)	The elapsed time from when the patient arrives at the emergency department until the fibrinolysis therapy is initiated.
Electrocardiogram (ECG)	A diagnostic procedure in which leads are attached to patient's arms,

	legs and chest wall to record the electrical activity (rhythm) of the heart.
EMS to Balloon (E2B)	From arrival of EMS at the scene to balloon inflation/device.
Fibrinolysis therapy (fibrinolysis therapy)	Administration of medication to dissolve clots in the immediate acute phase of myocardial infarction.
First Response	The first health care provider on the scene. Usually paramedic/EMS.
Infarction	See Myocardial infarction.
Myocardium	Heart muscle.
Myocardial infarction (MI)	Damage or necrosis of a region of the myocardium caused by an interruption in the supply of blood to the heart, usually as a result of occlusion of a coronary artery.
OAPC	Ontario Association of Paramedic Chiefs (formerly the Association of Municipal Emergency Medical Services of Ontario).
PCP	Primary Care Paramedic. This level of paramedic is an entry level into basic life support for emergency medical service delivery.
Percutaneous coronary intervention (PCI)	Percutaneous coronary intervention (PCI) is a procedure in which the coronary arteries are mechanically reopened using a balloon or aspiration catheter and includes the placement of a stent in the blocked arteries.
Pharmacoinvasive PCI	A planned PCI after fibrinolysis. Direct transfer to the cath lab is already planned at the time of fibrinolysis. The transfer to the cath lab is not dependent on the response to the fibrinolysis therapy.
Primary PCI	Performing acute PCI immediately for the treatment of a STEMI as the primary form of reperfusion.
Rescue PCI	Performing PCI for STEMI after fibrinolysis therapy has failed to open the artery. The decision to perform rescue PCI is generally made 60-90 minutes following fibrinolysis.
Reperfusion	The restoration of blood flow, as in coronary reperfusion after fibrinolysis.
STEMI (ST elevation myocardial infarction)	On a 12-lead ECG, evidence of myocardial damage causing ST segment elevation.